

# Eni for 2015

## Sustainability Report





# Sustainability Report

## Contents

Message to our stakeholders	2
Eni in the world	4
Responsible and sustainable business	6
Materiality analysis	8
Innovation	10
Eni and climate change	14
Human rights	20
Local development	22
Safety	28
People	32
Environment	36
Reporting Principles and criteria	40
Independent Auditors' Report	41

### Annexes:

- Eni for 2015 - Sustainability Performance
- Eni for Transparency
- GRI Content Index (available on eni.com)



For further information: eni.com

## Message to our stakeholders

2015 has been an important year. It has witnessed the engagement of the international community and the public opinion in a dialogue and debate, aimed at the quest for a new sustainable development paradigm and a low carbon energetic model.

The United Nations International conference on Finance for the Development, the UN General Assembly for the launch of the new Sustainable Development Goals (SDGs) and the Conference on Climate held in Paris (COP 21) all marked crucial moments of this debate.

Even Pope Francis' encyclical *Laudato si'* invites us to 'till and keep the garden of the world', urging each one of us to assume responsibility regarding the future of the planet.

This means that also companies must be leaders of this change, adapting their business models to contribute to the common wealth, and creating value in the long-term.

Eni has always embraced a sustainable and locally oriented approach, accompanying Countries in a growth path that aims at their development even in businesses outside the oil and gas sector, and promotes environmental protection and health and safety safeguarding as absolute priorities. All our local and global initiatives arise from the people's needs: it's our way to express respect for the different cultures. We are local, we live together with the local communities, working in order to enable them to reach a sustainable and long-lasting development. We have been the first to search for and produce gas not only for exportation, but also for the development of local markets, building infrastructures for the production of electric energy and its consumption. Access to energy is

in fact an essential condition for economic growth and development. We have risked as a company, investing in projects that are far from our core business, and putting our skills to the service of the communities.

We have transferred know-how and supplied clean energy, respecting the environment and the territory, and taking risks alongside Countries that have hosted us, to grow together.

Our commitment in the Countries has also been to stimulate the diversification of their economies, improving health assistance and infrastructures, promoting education and training.

We consider the territories where we work as our home. This is why the protection of health, safety and the environment of who lives and works in the Countries where we operate, is a priority for us.

We constantly monitor our people's health, also through continuous analysis on the eventual health impacts of our activities. The same attention is given to the safety of those who work with us.

We have been investing, for years, in training and in disseminating our safety culture at all company levels, reducing therefore the injury frequency index by 47% in the last 3 years; a fact that placed us at the top of the industry.

We look at the environment, the ecosystems and biodiversity with the same dedication. We adopt the best technologies everywhere, counting on research and innovation to explore new and innovative solutions: every day we monitor thousands of parameters in all our operating sites

in Italy and worldwide, and we study new prevention methodologies in a continuous improvement cycle. The challenge, now, is to build a future where everyone can access energy resources in a sustainable way. To that end, we have set, in 2015, the basis to resolutely pursue a low carbon model.

During the COP 21, we recognized the +2 degrees scenario, and we adjusted our climate change strategy relying on a portfolio and a development strategy that ensure maximum resilience in progressively decarbonized scenarios.

Our organic growth is based on a conventional asset portfolio. Since 2010, we have reduced our GHG emissions by 28%. In the future, we aim at a further reduction of 43% in our upstream emissions index, by decreasing flaring and fugitive methane emissions and increasing energy efficiency.

We invest in the gas chain, the fossil source with lowest carbon content, building, thanks to recent discoveries, a portfolio with an increasing gas share, starting from the current 58% of resources (3p+ contingent).

We believe that natural gas will help meet most of the growing global energy needs and that it is the ideal energy resource to back up renewables. With this in mind, we have created our new Energy Solution division, whose mission is to evaluate and develop growth opportunities in the renewable energy business sector. This will increase our ability to respond to the energy needs of the local communities.

Moreover, we are actively committed in asking for

a global carbon pricing which will lead to a gradual reduction in the use of the most polluting resources. Thanks to the Oil and Gas Climate Initiative, we promoted a joint action with the other companies in the energy industry to find practical solutions to reduce emissions.

While pursuing these solutions we use maximum transparency and clarity towards all stakeholders through the establishment of a continuous and proactive dialogue and the application of actions to protect a sound and shared business. We promote a transparent approach in the conduct of our business activities also by joining the Extractive Industries Transparency Initiative (EITI) and by dialoguing with the Governments of the Countries that have not formally joined the initiative yet. Our commitment in this direction brought us to strongly support the voluntary publication of payments in the Countries where we operate, believing that transparency is a prerequisite to fight international corruption.

Corporate social responsibility for Eni is substantiated with a lasting and sustainable corporate approach but it is above all, along with our corporate culture, a distinguished trait that marks everyone working in Eni. This is what makes us credible and valued in the Countries where we operate. This is what allows us to build a future of sustainable growth.



Claudio Descalzi  
Chief Executive Officer



# Eni in the world

Eni is an integrated energy company that employs more than 28,000 people in 66 Countries around the world. It is a key player in the exploration and production of oil and natural gas, the refining and sale of petroleum products, the generation and marketing of electricity.

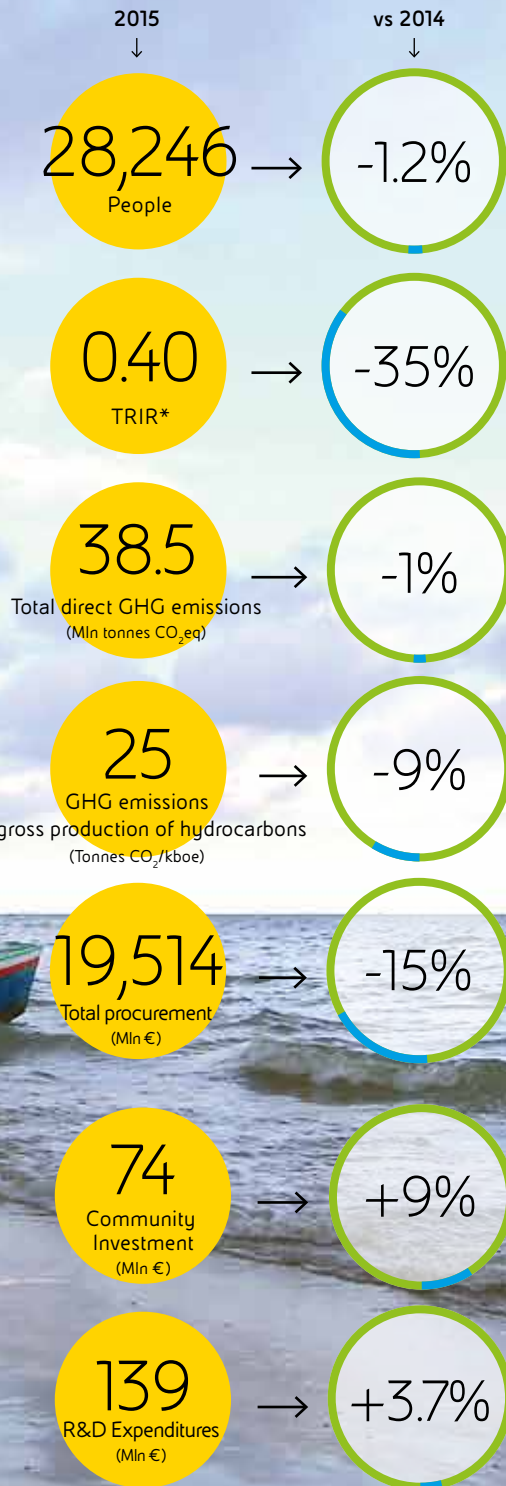

\* (total recordable injuries/hours worked x 1,000,000)

# Eni's activities

## Upstream

Eni engages in oil and natural gas exploration, field development and production, mainly in Italy, Algeria, Angola, Congo, Egypt, Ghana, Libya, Mozambique, Nigeria, Norway, Kazakhstan, UK, the United States and Venezuela, overall in 42 Countries on 66.

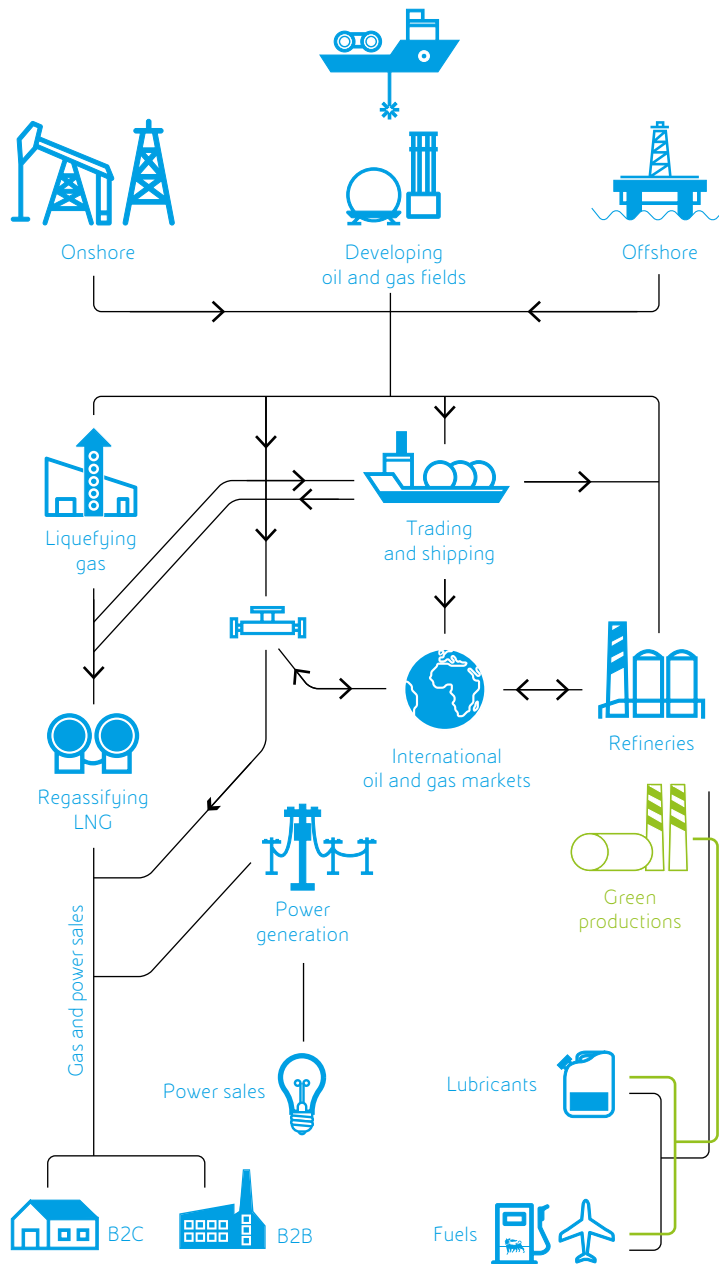

## Mid-Downstream

Eni sells in the European market basing on the portfolio availability of equity gas and long-term contracts; sells LNG on a global scale. Produces and sells electricity through gas plants. Through refineries, Eni processes crude oil to produce fuels, lubricants that are supplied to wholesalers or through retail networks or distributors. Eni engages in the trading of oil, natural gas, LNG and electricity.

# Eni worldwide presence

	E&P	G&P	R&M	
Austria		●	●	Europe
Belgium		●		
Croatia	●			
Cyprus	●			
Czech Republic			●	
France		●	●	
Germany		●	●	
Greece		●		
Greenland	●			
Hungary		●	●	
Ireland	●			
Italy	●	●	●	
Luxembourg		●		
Norway	●			
Portugal	●			
Romania			●	
Slovakia			●	
Slovenia		●	●	
Spain		●	●	
Switzerland		●	●	
the Netherlands		●	●	
the United Kingdom	●	●	●	
Turkey		●		
Ukraine	●			
Algeria	●			Africa
Angola	●			
Congo	●			
Egypt	●	●		
Gabon	●		●	
Ghana	●		●	
Ivory Coast	●			
Kenya	●			
Liberia	●			
Libya	●	●		
Mozambique	●			
Nigeria	●			
South Africa	●			
Tunisia	●	●	●	
Australia	●			Asia and Oceania
China	●	●	●	
India	●	●		
Indonesia	●			
Iraq	●			
Japan		●		
Kazakhstan	●			
Kuwait		●		
Malaysia		●		
Myanmar	●			
Oman		●		
Pakistan	●			
Russia	●	●	●	
Saudi Arabia			●	
Singapore		●	●	
South Korea		●		
Taiwan		●		
the United Arab Emirates		●		
Timor Leste	●			
Turkmenistan	●			
Vietnam	●			
Argentina	●	●		America
Canada	●			
Ecuador	●		●	
Mexico	●			
the United States	●	●	●	
Trinidad & Tobago	●			
Venezuela	●		●	

# Responsible and sustainable business

Sustainability has been a cornerstone of Eni's genetic heritage since its foundation. It is a business dimension that creates value over time for

stakeholders, the company and society as a whole. Operating in a social responsible way means creating opportunities and promoting respect for people

and their rights, as well as protecting the environment. Sustainability has always been a "glocal" concept for Eni, both global and local at the same.

## Business model

Integrated risk management →

Integrated risk management model

Governance →

Clear and transparent governance rules

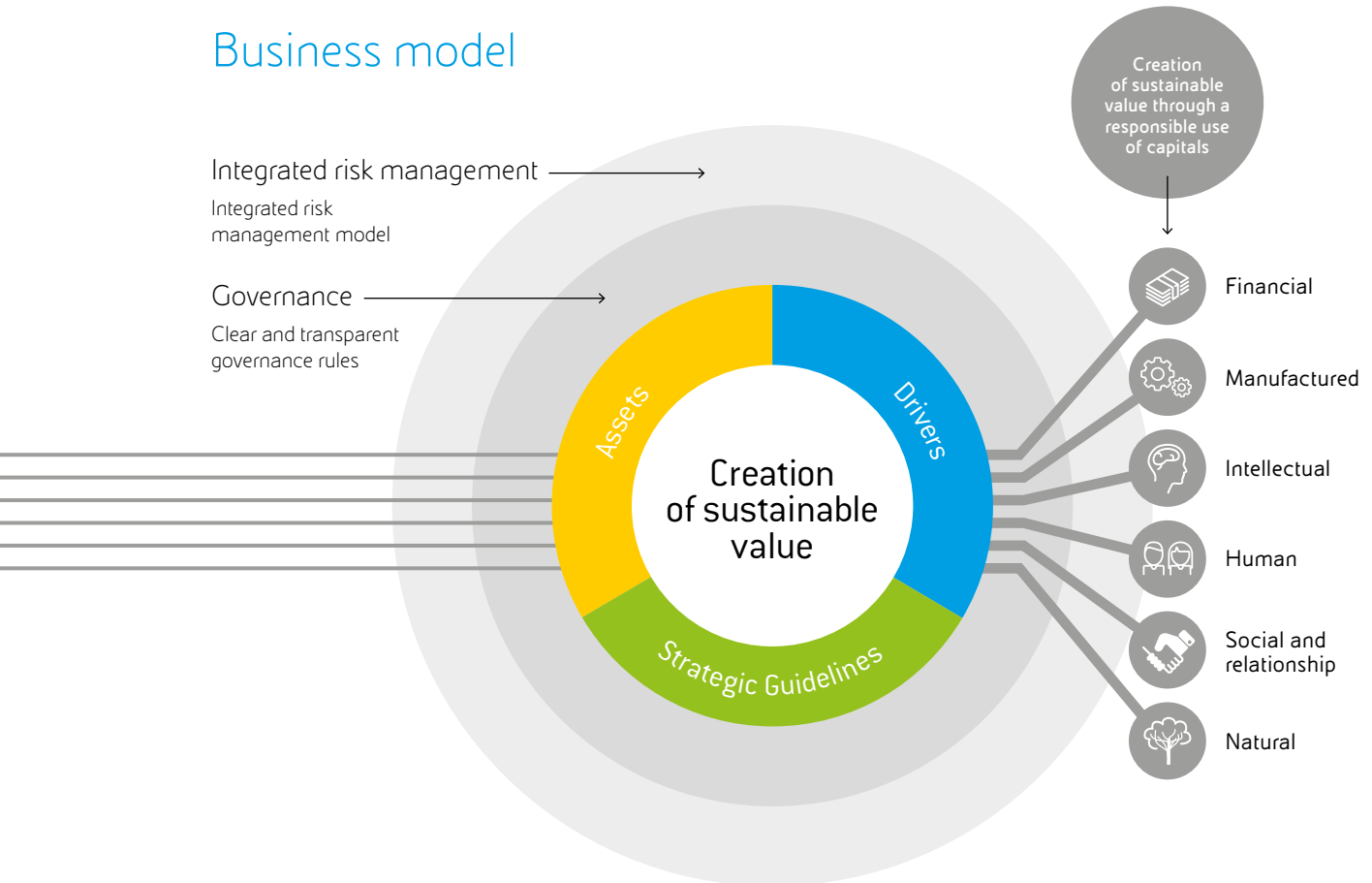

### What are the distinctive assets for delivering sustainable value?

- Skills in exploration activities and upstream operations
- Solid and competitive resource base
- Giant or super-giant projects
- Gas supply portfolio aligned to market conditions
- Large and loyal customer base
- Biorefineries
- Eni brand

### What are the strategic guidelines to use and develop our assets?

- Profitable and selective upstream growth
- Efficiency and cost control
- Focus on near-field exploration
- Reduction of time-to-market
- Operatorship
- Partnership with NOCs
- Trading of energy Commodities
- Gas supply contracts renegotiation
- Logistic and capacity rationalization/optimization
- Customer retention in gas and fuel markets
- Competitiveness of sale networks
- Development of green fuels

### What are the principles for delivering sustainable value?

- Integrity in business management
- Support Countries development
- Excellence in conducting operations
- Innovation in developing competitive solutions to face complexity
- Know how and skills sharing and equal opportunities for all Eni's people
- Integration of financial and non-financial issues in the Company's decisions and processes





The Corporate Governance system constitutes a key element for Eni business model. Along with business strategies, it supports the trust relationship between Eni and its stakeholders, contributing to achieving business results and creating sustainable value over the long-term. In 2014, with the new Board of Directors in power, a Sustainability and Scenarios Committee was established in order to further enhance the strategic value of sustainability. The Committee has consultative and advisory functions vis-a-vis the Board of Directors. In 2015 the Committee investigated several issues, including climate change and related topics; namely the Arctic and renewable energy sources.



The integrated risk management model pursues the objective of providing an organic and comprehensive vision of primary corporate risks, both financial and non-financial. It also aims at creating a set of more uniform methodologies and tools to support risk management and reinforcing knowledge at all levels, that adequate risk assessment and management can influence the achievement of corporate objectives. The model is based on impact assessment parameters that relates not only to financial aspects, but also to the social, environmental and reputational ones. In 2015, 60 subsidiaries in 23 Countries were subjected to risk assessment.

### Integrity

Business management is founded on the principles of transparency, anti-corruption and respect for human rights.

→ **In 2015**  
**5,000 people participated in webinars Responsible leadership dedicated to a culture of integrity**

### Support for development

Eni's credibility also relies on the commitment to the social and economic development of the Countries in which it operates.

→ **In 2015**  
**Integrated Hinda project in Congo concluded**

### Operational excellence

Sustainable management of business as a driving force for obtaining excellent results.

→ **In 2015**  
**The discovery of globally important gas reserves in Egypt (850 billion cubic meters of gas)**

### Innovation

Innovation as a competitive factor in the search for sustainable solutions in complex conditions.

→ **In 2015**  
**More than 3,000 patents deposited and in force**

### Sharing

Sharing skills and expertise and equal opportunities for people.

→ **In 2015**  
**More than 8,000 people involved in the corporate knowledge network (+20% over 2014)**

### Integration

The financial and non-financial aspects as integrated factors in corporate decision-making processes.

→ **In 2015**  
**More integration of sustainability in the Four-year strategic plan**

# Materiality analysis





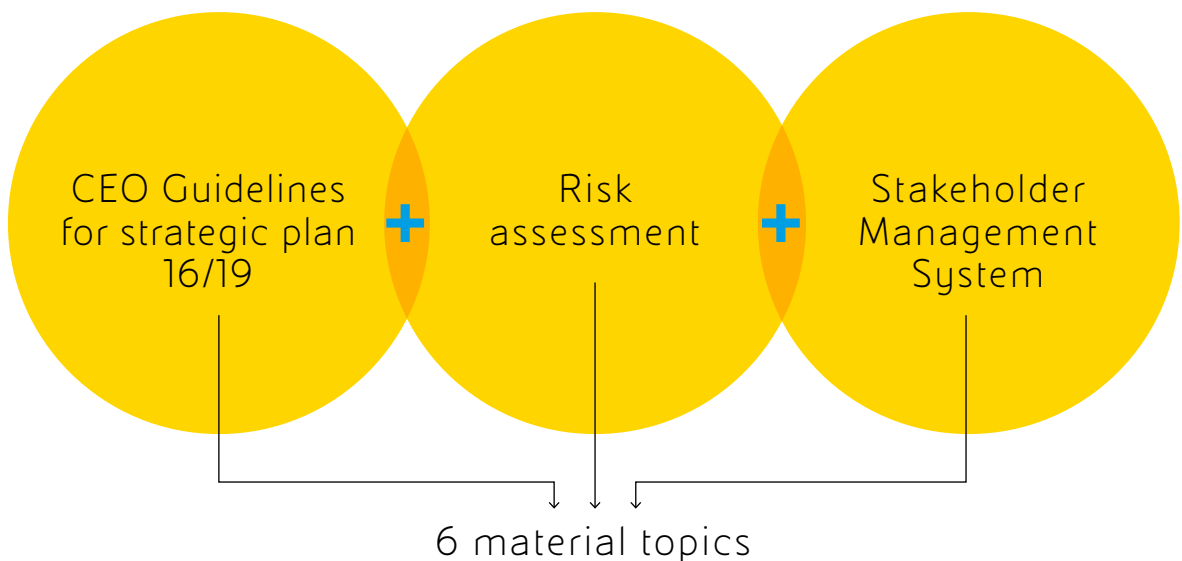
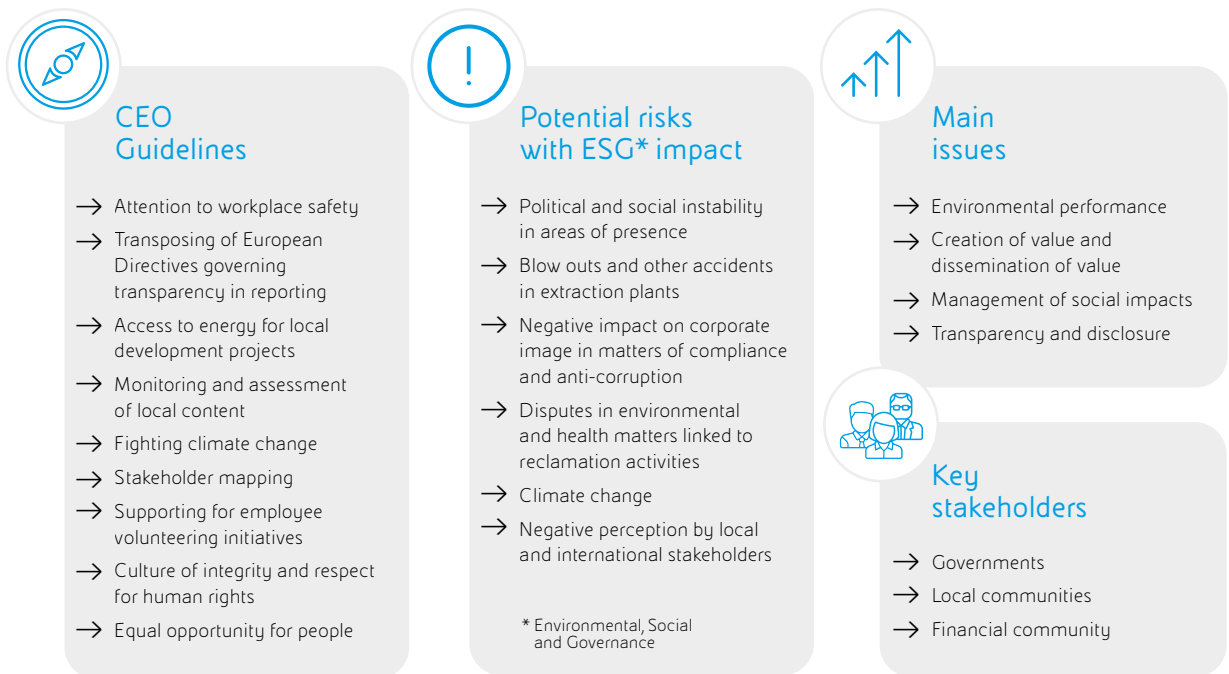

The materiality of the issues illustrated through the reporting system is the result of a process of identifying, evaluating and prioritizing those sustainability issues that significantly impact on the Company's ability to create value over the short, medium

and long-term. The process of materiality was based on analysis of three lines: the CEO's guidelines for the strategic plan, resulting from the scenario analysis to define the strategic directions of the four-year period; ESG risks to which Eni is exposed, identified

by internal risk assessment analysis; the evaluation of stakeholder management system (SMS) that reflects the primary sustainability requests from outside the Company. The findings have led to the identification of 6 relevant items.



## Sustainability objectives and results

Material topics	Commitments	Progress as at 2015	Objectives for 16/19
 <p><b>Integrity in business management</b> Anti-Corruption, Human rights, transparency</p>	→ <b>Dissemination of the integrity culture</b>	5,000 people participated to 'Responsible leadership' webinars	Extension of the 'Responsible leadership' to a broader public and new updated activities related to 'integrity'
	→ <b>Suppliers SA8000 audit</b>	SA8000 audit carried out on 16 suppliers/subsuppliers of which 8 in Vietnam, Algeria, Ghana, Ecuador and 8 follow-up in Indonesia, Mozambique, Angola, Pakistan	Prioritizing of violation risk of human rights in audit plans to be carried out on the supply chain
	→ <b>Transparency of payments to Governments</b>	Disclosure of governmental payment in 28 Countries with their consent (see Eni for Transparency)	Implementation of the new mandatory reporting regime and creation of a new support community to affiliates on EITI and on transparency issues
 <p><b>People safety and asset integrity</b></p>	→ <b>Reduction in the number of employee and contractor injuries</b>	Reduction in the number of injuries for the 11 <sup>th</sup> consecutive year (TRIR 0.40 in 2015 vs 0.62 of 2014)	Continuous improvement targeting zero level of injuries
	→ <b>Development and training of local people overseas</b>	Project Eni Junior Professor (JP), started in 2014, for training of future teachers in the oil&gas engineering at the Maputo University (Mozambique)	Intensification of cooperation with Universities in some Countries (Angola, Ghana) in order to align their curricula with the needs of local content
 <p><b>Equal opportunity for all people</b></p>	→ <b>Increase of women presence</b>	26.86% percentage of women on new recruitments	10% increase of women staff in Italy in the years 2016-17
	→ <b>Reduction in hydrocarbon volumes sent to process flaring (MSCM)</b>	4.28 million cubic meters/day	-25% to 2019
 <p><b>Fight against climate change Environmental impacts reduction</b></p>	→ <b>Reduction GHG upstream emissions</b>	0.18 tonnes CO <sub>2</sub> eq/toe	-43% to 2025
	→ <b>Percentage increase in the reinjection of produced waters</b>	56%	64% to 2019
	→ <b>Access to energy</b>	Integrated Hinda project in Congo concluded, electrification studies for two health centers in Angola conducted	Continuous integration of the 'access to energy' theme, taking into account various energy mix alternatives, in the local development projects
 <p><b>Local development/ Local content</b></p>			
 <p><b>Technological Innovation</b></p>	→ <b>Use of solar energy and energy storage in areas of scarce supply</b>	Development of innovative technologies on the concentrating solar power (CSP), energy storage and advanced bio-oil with the collaboration of MIT and Politecnico di Milano as well	Construction of pilot and demonstrative plants of newly developed technological solutions
	→ <b>Development of monitoring technologies, environmental protection and remediation</b>	Development and testing of innovative methodologies and protocols	Engineering of the most promising technologies and practical application of these
	→ <b>Reconversion of industrial sites to biorefineries</b>	180 tons of biofuel produced in the Venice biorefinery	Conversion of the Gela refinery and production launch of second generation biofuel

# Innovation

Technological innovation is for Eni a key element for making access to new energy resources effective and efficient, improving the use of existing resources and, at the same time, reducing environmental impact.

## Research to respond to the new energy scenario

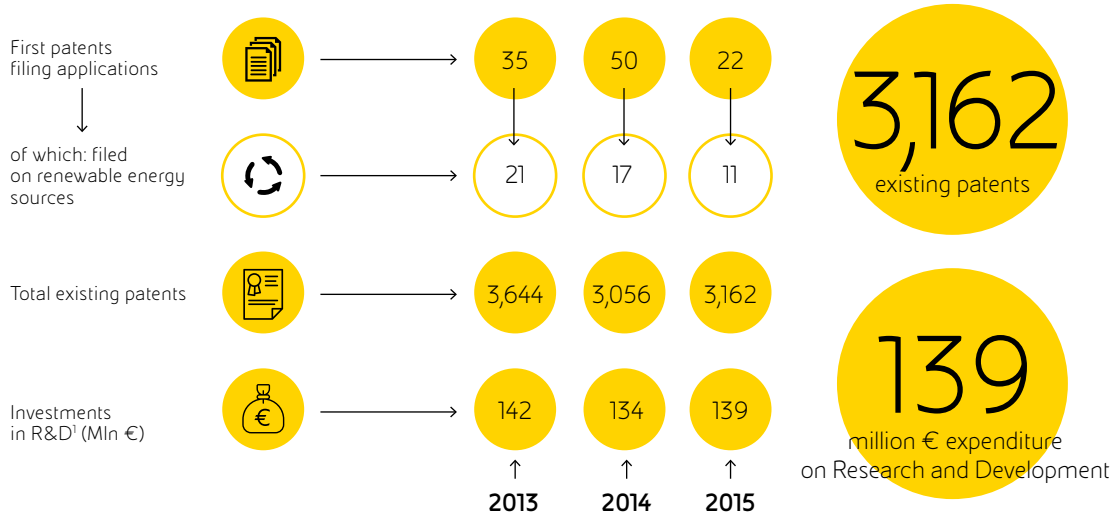
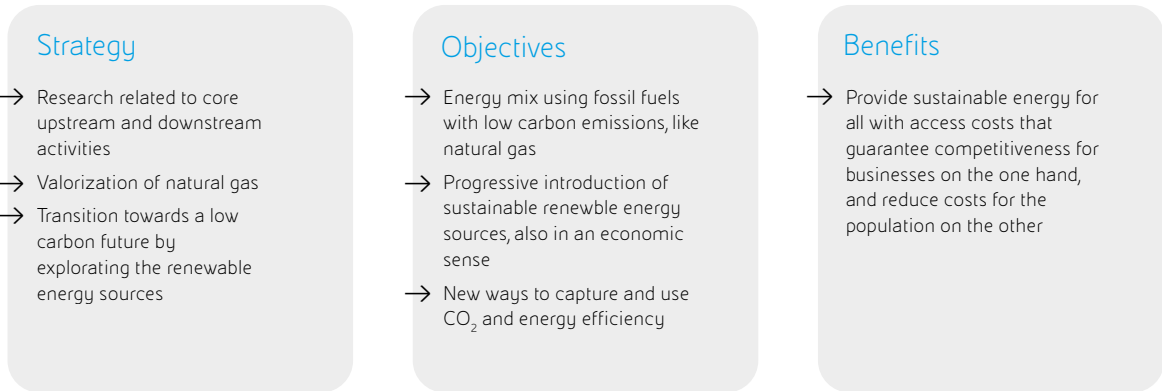

Regarding the transition towards a low carbon future, the three areas where Eni is directing most of its research relate to technologies for exploiting solar power and energy storage, the use of biomass and innovative technologies to protect the environment. The primary projects dealing with renewable

energy require: the use of technologies able to absorb specific amounts of solar radiation, also in conditions of scarce direct light (e.g. sunrise, sunset) as well and the development of technological capacities in thermodynamic solar power. As far as advanced biofuels are concerned, Eni is

mainly developing the production of oils obtained from agricultural waste, urban waste and microalgae. With regard to respecting the environment, Eni in addition to technologies for more sustainable management of hydrocarbon fuel production activities, is also focusing on reclamation research.

<sup>1)</sup> Figure doesn't include general overheads attributed to research activities and amortizations.

Activities in this field are focused on the development of easy to use tools for measuring and characterizing the contaminating component, on the integration of innovative

Physico-chemical and biological technologies for the measurement and modelling of contaminants, innovative technologies for the treatment of water on the development of

models simulating the dispersion of pollutants to precisely determine the objectives of reclamation, maximizing results in the specific area of intervention.



## Exploitation of solar power and energy storage

The research projects in solar power and energy storage are aimed at developing applications for provisioning electricity and steam in the oil&gas field, reducing the energy footprint in general (for example, in construction) and implementing sustainable initiatives to make electricity available in areas where it is lacking or scarce

(e.g. Sub-Sahara Africa). Research activities focus on the conception, development and subsequent application of technological solutions with high coefficients of innovation in respect to state-of-the-art technologies. Projects collaboration with MIT in Cambridge (USA) are continuing in this field. Amongst possible

applications for intermittent renewable or non-programmable energy sources, like solar power, energy storage ("Storage" project) has the purpose of ensuring continuity in the supply of energy. Projects in the solar power field are: "Concentrating Solar Power - CSP", "Luminescent Solar Concentrator - LSC" and "Advanced PV".

## Valorization of biomass energy

This research has the objective to identify and develop sustainable supply chains for complying with standards governing the quantity of biocomponents to be inserted into the fuel pool. One of the key projects in this activity is the "Second generation Green Diesel demo plant", dedicated to the creation of a proprietary process to produce microbial oils from biomass waste to be

converted into Green Diesel through the proprietary Ecofining™ process. The "Waste to fuel" project is focused on the production of bio-oil from the organic fraction of solid urban waste, purification sludge from wastewater treatment plants and other agricultural-food derived wastes. Other possible sources or processes are also being studied, like methane from biogas.



In 2015  
**180,000**  
 ton/year  
 of biofuels produced  
 in the Green Refinery of Venice



## Innovative technologies for respecting the environment

The R&D portfolio dedicated to the business of Syndial, the Eni company that provides integrated services linked to environmental restoration, is focused on water treatment projects. The "Water treatment" projects are related to the development of proprietary

technologies for the treatment of production waters, wastewater and groundwater.

The "Site reclamation and disposal" projects create highly eco-compatible techniques for soil reclamation, such as, the phyto-remedy for

biodegradation of organic compost or for the fixation of contaminant metals in the soil, with select micro-organisms and specific plant essences. The "Site characterization" projects develop new techniques and protocols for monitoring water, air and soil.



### The Clean Sea project

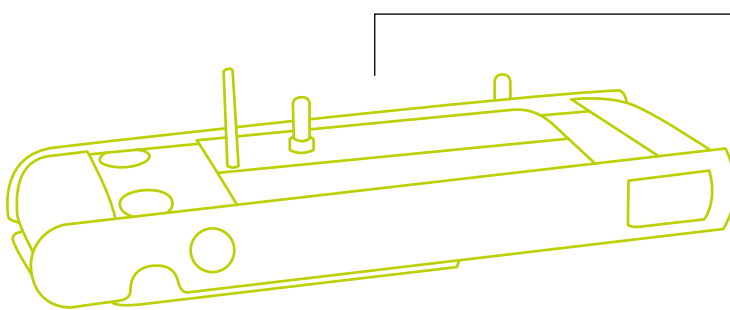

**Clean Sea** is an innovative undersea robotic technology developed and perfected by Eni. It allows to perform automatic environmental monitoring and inspections on oil&gas offshore plants.



### The Rapid Cube project

Eni is developing the **CUBE** system based on a proprietary and patented technology to respond to unforeseen oil spills at sea. CUBE was designed to be the last line of defence if a blow out (the uncontrolled spewing of oil from a well) is not intercepted in time with standard emergency systems.

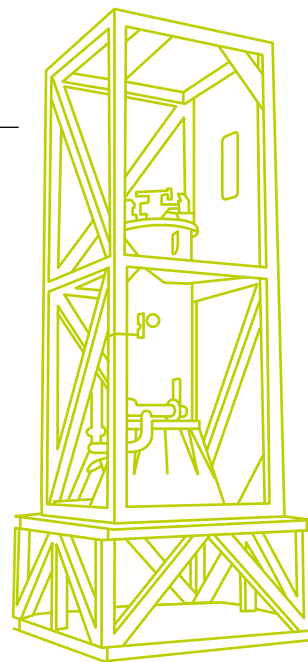

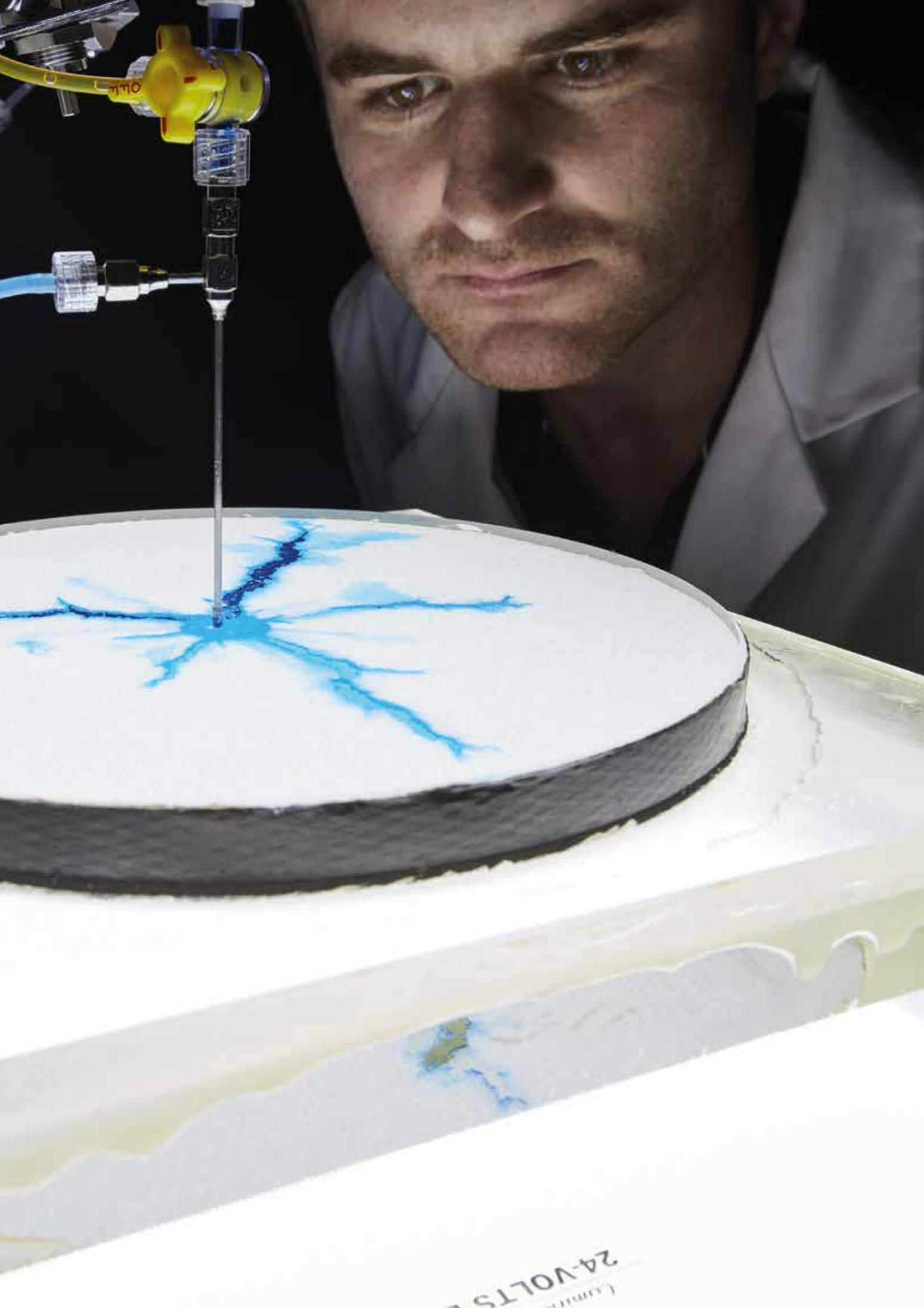

24-VOLTS  
Lumin

# Eni and climate change

Eni recognizes the scientific evidences presented in the IPCC Fifth Assessment Report and the necessity to limit the rise of the global temperature to less than 2 °C above pre-industrial levels.

To this end Eni is carrying on a strategy on climate change that has already produced significant results over the last 10 years in terms of reductions of routine flaring and carbon intensity. The reduction of GHGs is accompanied by

a strategy focused on natural gas, that is the fossil fuel with the lowest carbon content.

Furthermore Eni has created the Energy Solutions Department to integrate renewable sources in the

business model. Eni supports the need to introduce a carbon price for the GHG emissions at a global level to discourage higher emissions options and to stimulate investments in low carbon technologies.

**“Our challenge is to build a low carbon future in which everybody can have access to energy sources in a sustainable way”.**  
CEO Claudio Descalzi

## Governance

In 2015 Eni has adopted a ten-year action plan on climate. This Plan has been approved by the Board of Directors that has a central role in the definition of policies, strategies and the sustainability performance

review. The Sustainability and Scenarios Committee has supported the Board in the assessments related to climate change and energy scenarios. In 2015 the second training module of the UN Global

Compact LEAD Board Programme has been held, and it was dedicated to the Board's roles and responsibilities on sustainability issues with particular reference to climate change.

Topics covered by the Sustainability and Scenarios Committee 2015 about climate change:

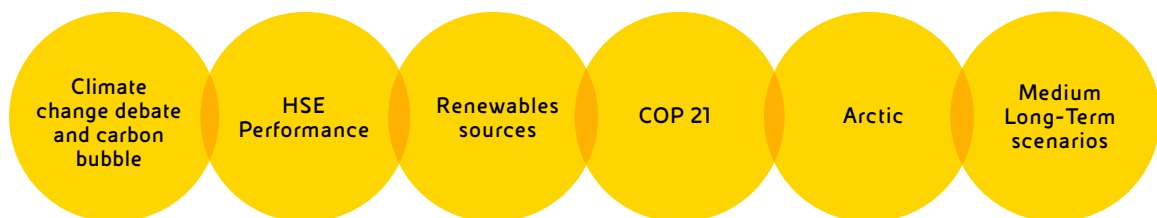

The 2016 CEO Annual variable incentive plan, as the previous year, has been defined with a target on Environmental

Sustainability and human capital weighted 25%: this is composed by an objective on CO<sub>2</sub> emissions and another on safety.

Based on that also the objectives of the Managers with strategic responsibilities have been declined.

## Risk management

In 2015 Eni has included the climate change among the top business risks through the internal Integrated Risk management process, established in 2010. The risk assessment is referred both to the operational consequences of future international climate

policies and to the potential physical impacts on industrial assets. For this reason, in addition to the 2025 Action Plan, Eni has decided to adopt a Carbon Pricing Sensitivity Analysis with price of 40 \$ per tons of CO<sub>2</sub> to assess all main strategic development projects

and has launched an initiative on climate change adaptation with the support of the CMCC (Center Euro-Mediterranean on Climate Change) to assess risks and to identify adaptation measures. The business strategy and the climate strategy allow to minimize the risk.

## Comparing Scenarios

Eni believes that natural gas - the fossil fuels with the lowest content carbon - can be complementary to renewable sources and can help to meet a substantial part of the world

energy demand in the next decades in a more sustainable scenario. In line with the IEA scenarios (the New Policy Scenario IEA and 450) and with the NDC<sup>2</sup> presented for the COP 21, the

global energy demand will continue to grow in relation to population and GDP increases and it will be satisfied by a combination of fossil fuels and renewable sources with a role gradually increasing.

IEA 450 Scenario: percentage of energy demand met by oil and natural gas

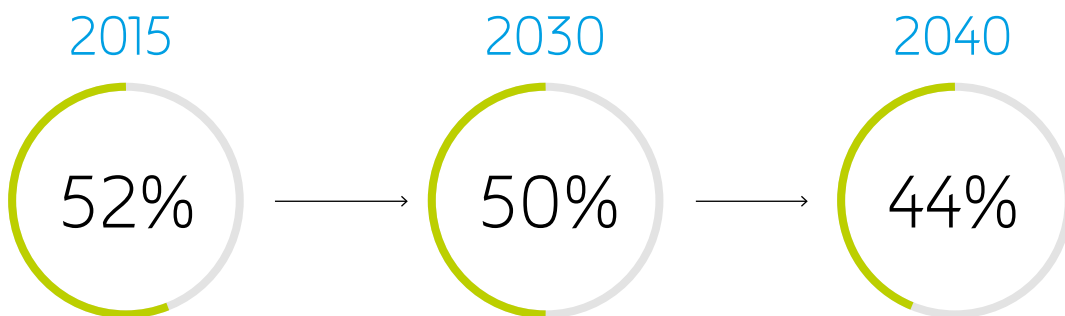

The oil demand will not peak before 2030 due to the growing consumption in emerging Countries and technological and economic constraints,

in particular in the transport sector. Eni's forecast for oil prices is in the lower range of the industry estimates (\$ 65/b real term from 2019) and well

below the assumptions of both IEA scenarios. This price is used to evaluate all new initiatives and applied to assess project economics, before sanctioning.

2) Nationally Determined Contributions.

## Conference of Parties (COP 21)

In 2015 the 21<sup>st</sup> Conference of the Parties (COP 21) of the UNFCCC (United Nations Framework Convention on Climate Change) has been held in Paris. Eni has promoted several initiatives to sensitize Countries on the need for an ambitious agreement in Paris; in first place through the Oil and Gas Climate Initiative, led by the CEOs of 10 oil&gas companies. Eni's CEO has spoken

in favor of the adoption of carbon price instruments with the Paying for Carbon letter. The Global Climate Agreement reached in Paris has been a positive step by virtue of the ambitious commitments - although not sufficient to reach the targets of the Agreement - that have emerged, the willingness of industrialized Countries to financially support

Developing Countries and the Governments' commitments to present National Determined Contributions to reduce emissions. The plans of Developing Countries are of particular interest for Eni because they can constitute the long-term reference for the national energy and economic policies, useful for the declination of local development projects.

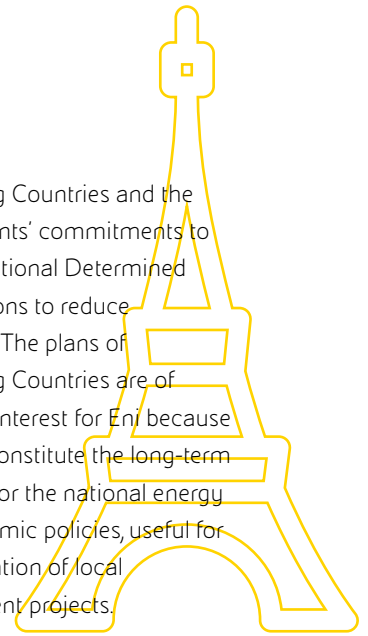

## Eni business strategy

Thanks to the business strategy adopted, even in the IEA 450

scenario that limit the rise of temperature to less than 2 °C,

there are no impacts on the assets value.



### Organic growth and conventional assets development in low cost areas:

conventional hydrocarbons account for 99% of the 2015 equity production of 1,760 kboe/d and most of the resource base of 38 billion barrels.



### Natural Gas:

proven reserves are made up 48% by gas and this percentage increases in reference to probable and possible reserves.



### Exploration efficiency and low cost structure as levers in managing the portfolio evolution in the long-term:

Eni has the most efficient cost structure among the peers with less than 20 \$/b. The exploration success, with almost 12 billion boe resources discovered since 2008 at a unit cost of 1.2 \$/b, has granted the lowest unit cost of development and operating expenditures.



### Dual exploration model:

a model that allows to anticipate the cash flows of exploration discoveries and to reduce investments.

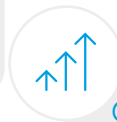

### Growth plan with simple and modular projects to maximize flexibility and to optimize spending and exposure:

thanks to this approach and the optionality of the portfolio, Eni lowered the average break-even price of the projects from 45 \$/b to 27 \$/b of Brent equivalent 2016, the lowest breakeven among peers. The onshore portfolio presents a break-even of 15 \$/b and the shallow and deep water projects break-even at 30 \$/b.



### Operatorship:

high level of operatorship to guarantee the best operational standard.

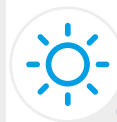

### Climate strategy:

based on direct emissions reduction, low carbon portfolio and commitment in renewables sources.



## Portfolio resilience

Over the last 2-3 years, the concept of "stranded assets" has gained traction among some investors. The highest

risk of stranded assets is linked to the barrels with the highest production costs or the ones that have the highest CO<sub>2</sub>

content. In this sense, strategy and the portfolio composition minimize this risk.

## Climate strategy

Since 2010 to date the strategy has allowed the reduction of the total GHG emissions by 28% and the reduction of GHG

upstream emissions on operated production by 25%. The ten-year Action Plan on climate change to 2025 foresees

a reduction target of 43% of the GHG performance index on operated production compared to 2014.

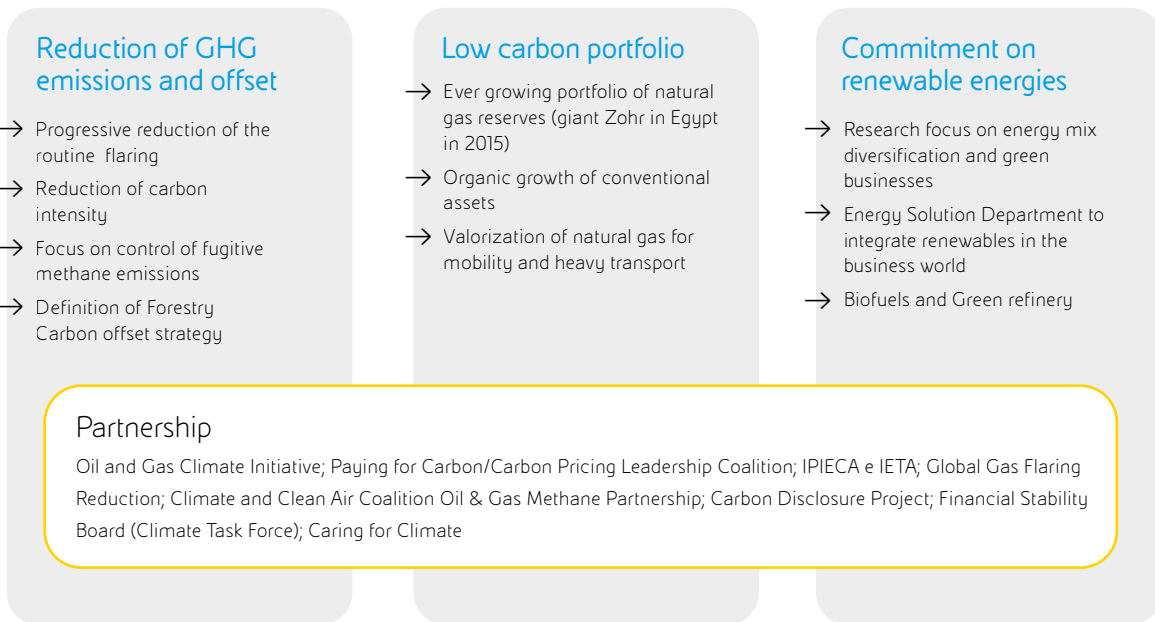

For the emissions Scope 2 and Scope 3, see Sustainability Performance on page 25-26.

## GHG Emissions

(TCO<sub>2</sub>eq/toe)

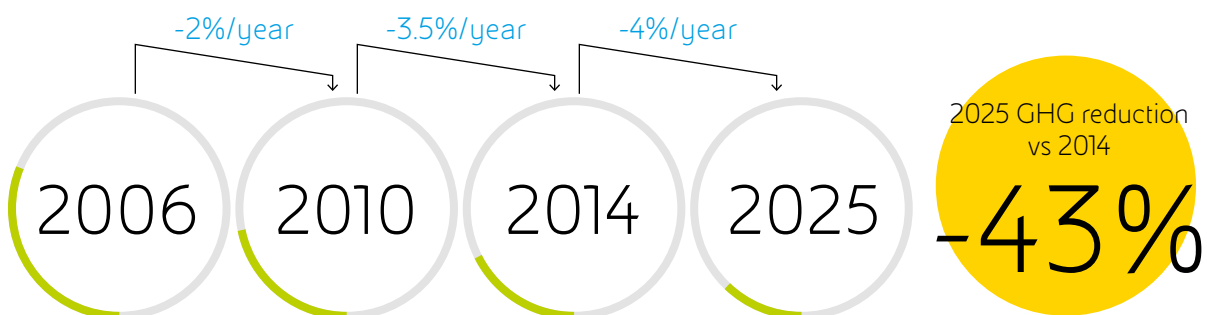

## Reduction in process flaring

In 2007 Eni initiated a progressive reduction program of the gas sent to flaring, thanks to an emphasis on the

production of electricity for local populations, for domestic consumption and for export. When these practices were not

possible, Eni realized re-injection systems in natural gas reservoirs. The objective is to reach zero routine flaring by 2025.

### Volumes of hydrocarbon fuels sent to process flaring

(MSm<sup>3</sup>)

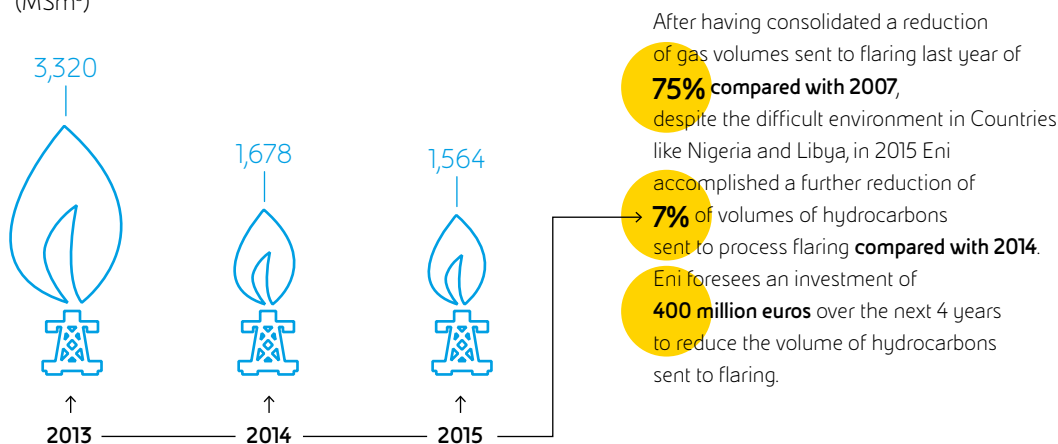

## Commitment to energy efficiency

The energy efficiency programs implemented since 2008 have resulted in operational savings of approximately 370 thousand tons of petroleum equivalent a year, of which more than 20% from optimized logistics in the upstream, equal to an

accumulated reduction of over 1 Mt CO<sub>2</sub>eq/year. Further engineering modifications in the power sector were added to these interventions, thanks to which a reduction in energy intensity over the next four years is predicted for plants that

already operate with high efficiency, like combined cycle gas turbine plants. Many of these interventions were possible thanks to energy management systems in compliance with standard ISO 50001, which Eni introduced already in 2010.

## Reduction in fugitive methane emissions

The reduction of fugitive emissions represents a new challenge for the O&G companies. Eni has already reduced in 8 subsidiaries the emissions of 0.6 Mt of CO<sub>2</sub>eq

estimated in 2015 vs. 2014. Furthermore, Eni presented a methane emissions control program in the Upstream activities aligned with requirements promoted

by the Climate and Clean Air Coalition. Over the next 10 years, all of the most important Upstream operating sites will be covered by monitoring campaigns.

## Renewable energy

To underline its commitment to renewable energy sources, in 2015 Eni founded the new Energy Solutions Department that reports directly to the CEO. The Division has the mission to complement and integrate the traditional energy sources with the production of energy from renewable sources, through profitable projects on an industrial

scale. There will be two types of power generation projects: Brownfield projects, to seize all the industrial and contractual synergies in the existing production sites and Greenfield in sites that are not linked to Eni industrial areas for on-grid and off-grid projects. The projects are also part of the Cooperation model with the Countries to

respond to their energy requirements. The commitment on renewable, in particular in solar, started 35 years ago and has been concentrated in the commercial production of solar modules, R&D activities and collaborations with Italian and foreign universities. Research is focusing mainly on 2 technologies: concentrated solar and the development of advanced biofuels.

## Biofuels and Green refinery

To meet the challenges posed by the refining structural crisis, Eni has decided to convert the older industrial sites, building in Porto Marghera the first biorefinery in the world, obtained from the conversion of a traditional refinery via the Ecofining® proprietary technology. In Porto Marghera Eni produces the Eni Diesel +, the new diesel that, with the 15% renewable component, preserves the engine efficiency and contributes to reducing CO<sub>2</sub>

emissions by 5% compared to the diesel in the market. The biomass used, converted into biofuel, is certified according to the International Sustainability & Carbon Certification (ISCC) standard, which guarantees respect for environmental requirements, as well as social requirements. Furthermore Eni continue to invest in the research for new biocomponents to input into fuels (see Innovation section). 

In Gela through the conversion of the existing refinery the second biorefinery will be launched

## International partnerships

Eni actively participates in the primary international climate initiatives. One of these initiatives involved Eni in the development of the "Oil and Gas Climate Initiative" (OGCI), launched in 2014 in collaboration with other companies from the petroleum sector<sup>3</sup>. In 2015, the CEOs of the companies of the OGCI, at an event in Paris, launched a Joint Collaborative Declaration that announced their collaboration in the area of climate change, where they presented a joint report that collected the

measures adopted for the management of GHG emissions and climate impacts over the long-term. Furthermore, Eni, with Bg, Bp, Shell, Statoil and Total, sent a letter to the United Nations and the governments of the entire world to define a global plan of action on carbon pricing and to promote natural gas as a bridge solution for the climate change challenge. Eni is working with this group of companies and the World Bank on the initiative "Carbon Pricing Leadership Coalition" aimed at

building an effective dialogue with governments and companies around the world. Since 2003 Eni participates in the CDP (Carbon Disclosure former Project) and in 2015 was among the few companies oil&gas to have obtained the highest rating (100/100) with respect to disclosure. Finally, Eni participates in the Task Force established in December 2015 by the Financial Stability Board (FSB-TCFD) to develop recommendations and International guidelines on the reporting of changes climate related risks. 

<sup>3</sup> The current group members are Bg, Bp, CNPC, Eni, PEMEX, Reliance, Repsol, Saudi Aramco Shell, Statoil and Total, which together represent 20% of world production.

# Human rights

Eni is committed to ensuring respect for human rights, in line with the United Nations Guiding Principles on Business and Human Rights, applying a

transversal approach focused on continuous improvement. Eni maintains constant dialogue with stakeholders and experts, in particular within the Human

Rights Task Force of IPIECA (the International Petroleum Industry Environmental Conservation Association) and the United Nations Global Compact.

## Respect for human rights in the supply chain\*

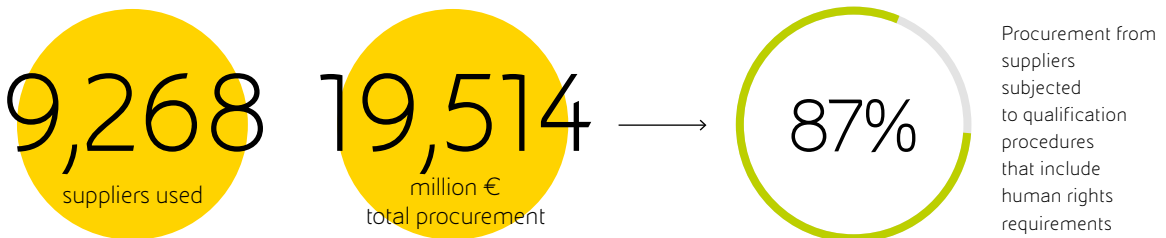
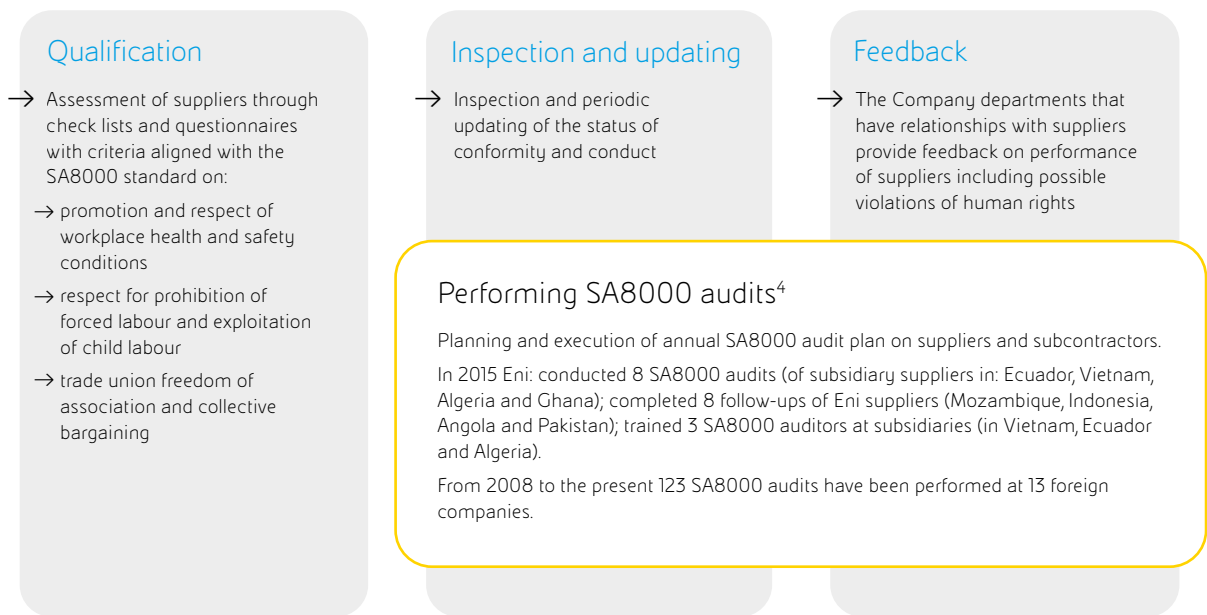

\* For the respect of HSE supply chain parameters, please see chapter Safety of this document.

4) SA8000 is an international standard governing Corporate Social Responsibility, in order to certify some aspects of corporate management involving corporate social responsibility, including respect for human rights, workers' rights, respect for health and safety in the workplace, the production chain and the consumer chain.

## Respect for human rights in local communities

To improve prevention of any possible violations of human rights in the communities where Eni operates, the following two operating instructions were issued over the course of 2015.

### Land Management Operating Procedure

- governs land acquisition processes in compliance with international standards and best practices. In particular:
  - livelihood restoration
  - non discrimination and respect for vulnerable groups
  - informed consultation and participation of involved communities
  - access to mechanisms for collecting grievances and damage remedies

### Operating procedure for Grievance Management

- governs systems for collecting and managing local complaints - grievance mechanism - to facilitate identification of solutions and to contribute to management of reported criticalities 
- includes channels for receiving grievances, verbal and in writing, for local stakeholders impacted by project activities
- defines assessment methods and grievance resolution
- is added to the procedure in place for collecting reports, in confidential or anonymous form, relating to the internal control system or other materials related to violations of the Code of Ethics

## Human Rights Impact Assessment

Eni's commitment also includes specific local interventions. In 2015, a preliminary assessment project was initiated in Myanmar on the potential impacts on

human rights regarding activities carried out by the subsidiary in the Country. Eni was among the first companies to acquire onshore exploration rights in the Country after its

recent opening to foreign investors. To carry out these activities Eni relied on the support of the Danish Institute for Human Rights. 

## Human rights in the Security process

To improve management of the risk of violating human rights in supplying equipment to the public and private security forces that operate at Eni sites, basic operating instructions were made available to subsidiaries' security managers that mirror the provisions set forth in the Voluntary

Principles on Security and Human Rights. Training sessions were also held on "Human Rights & Security" for the private security forces that work at Eni sites in Kenya, and in early 2016, two additional training events were held in Venezuela and Ecuador.

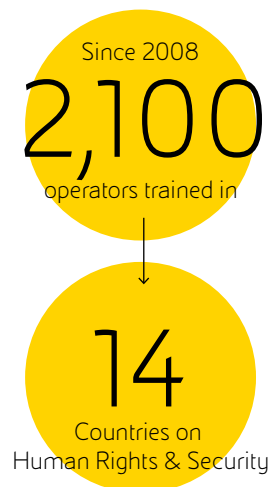



# Local development

One of the factors of Eni success is the ability to establish long-term relationships with producing Countries providing plans and actions with local development goals. For Eni, a responsible and sustainable relationship with the local communities has been a dimension of the Eni way of

doing business since its foundation. Knowledge of local realities is a fundamental part of the process and it helps to respond to the needs of people, instilling a reciprocal relationship based on awareness and respect. This integration permits identifying participatory programs, projects and activities,

through participatory methods, that respond to real needs in compliance with local development programs. Eni's commitment to act responsibly and sustainably is evident in all of its operating phases, based on an approach aligned with the guidelines set forth in ISO 26000.

## The 6 operating procedures

- Local stakeholders engagement
- Analysis of the local context
- Community investment plan
- Monitoring, reporting and audits
- Local content
- Land acquisition and management

## Results obtained as of today

- The development and sustainability system was applied in 2014 in the following pilot Countries: Mozambique, Congo, Kazakhstan (AKBV), Pakistan, Angola.
- In 2015 it was extended to: Nigeria (NAOC), Egypt (IEOC), Gabon, Ghana, Italy (DICS, Enimed, DIME), Ecuador, Libya, Indonesia, Myanmar.
- In 2015 adherence to the guidelines set forth in ISO 26000 was verified in: Kazakhstan (AKBV), Congo, Italy (Enimed), Pakistan, Mozambique.

## Operating phases

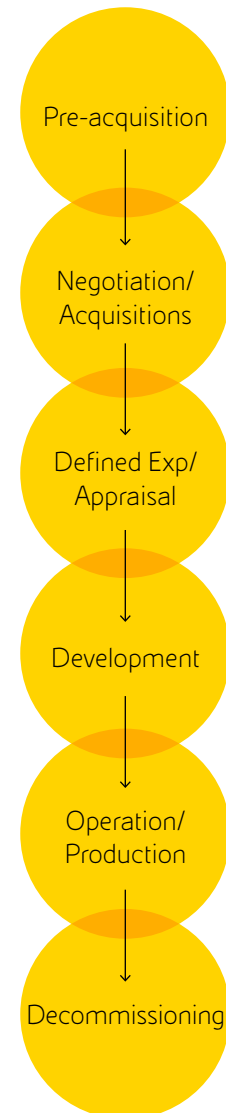



## Distinctive areas of Eni's approach to development

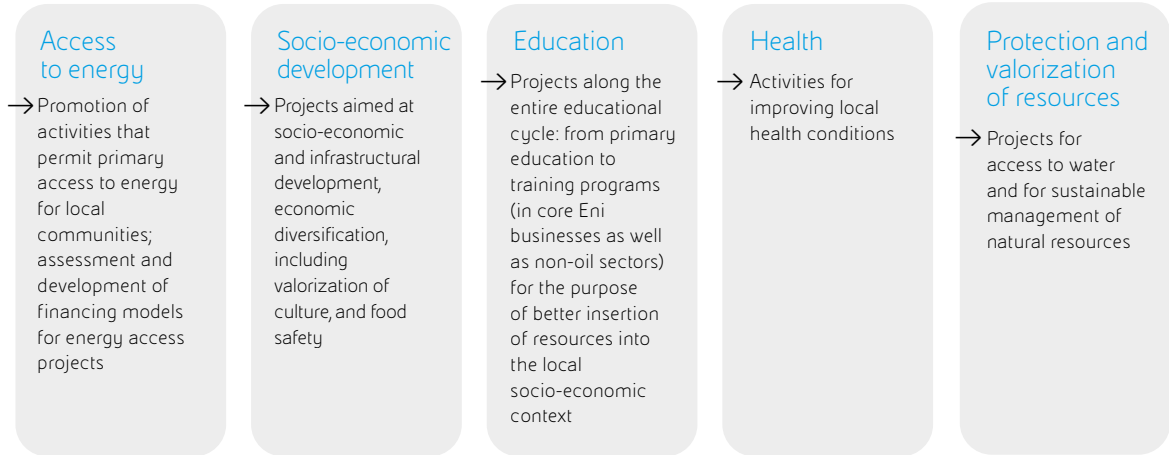

## Community investment 2015

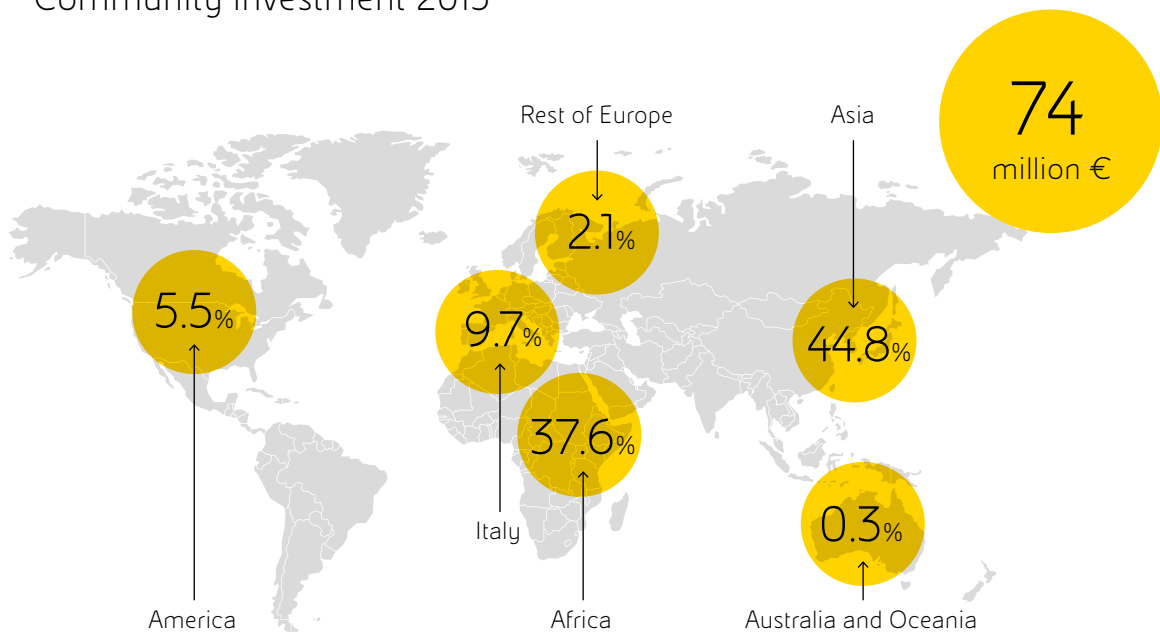

## Access to energy

The lack of energy is recognized as one of the most serious social problems. This means lack of adequate health services, hinders access to basic education and gender equality, and compromises the development of productive activities. In Africa, 56%<sup>5</sup> of the population has no access to

electricity and 66%<sup>5</sup> does not have access to improved cooking systems. Eni placed access to energy at the heart of its commitment to Africa, by initiating projects for energy access of populations, by promoting energy plans for developing domestic resources, infrastructure for production

and by investment in electricity distribution. A concrete example of this commitment are the power plants in Nigeria and Congo, which today produce 20% and 60% respectively of the national electricity production, with a significant reduction of flaring gas in both Countries.

5) Africa Energy Outlook 2014.

Eni's commitment continues in Congo, through the integrated Hinda Project (PIH) for the communities in the areas surrounding the onshore industrial M'Boundi plants. The project is an example of how access to energy is a prerequisite to satisfy the primary needs of the community. As of today 22 water wells have been constructed, of which 17 are powered through solar energy,

3 through electricity-generators, 1 connected to the main electricity network and 1 powered using a manual pump. [www](#)

In 2015, studies in Angola continued for the planning of electrification of two health centers in the Luanda province: Kilunda and Quicama. Both studies have the objective of offering a practical solution for the production of electricity through solar power systems. [www](#)



In 2015 Eni was an 'Official Partner for Sustainability Initiatives in African Countries' at Expo. The focus of the partnership was

the broad issue of access to energy in Africa, which for Eni translates into sustainability, cooperation with local

communities and innovation and research. The events at Expo dealt with Eni projects and initiatives in favour of African nations:

**1**  
Nigeria - Farmers Day and Green River Project, agricultural development in the Niger River Delta.

**2**  
Congo - Sustainability in African territories, projects: Hinda and improved cooking stoves for preparing local foods.

**3**  
Mozambique - Theatre So Good project. [www](#)

## Socio-economic development

Eni has invested for decades in building long-term partnerships with the Countries of presence. This allowed a broader and

more diversified local development in support of sustainable economic activities, even in areas not

directly connected to oil&gas business. It also contributed to the creation of value for people and local businesses.

## Local procurement in 2015 by Country

% procurement on the local market

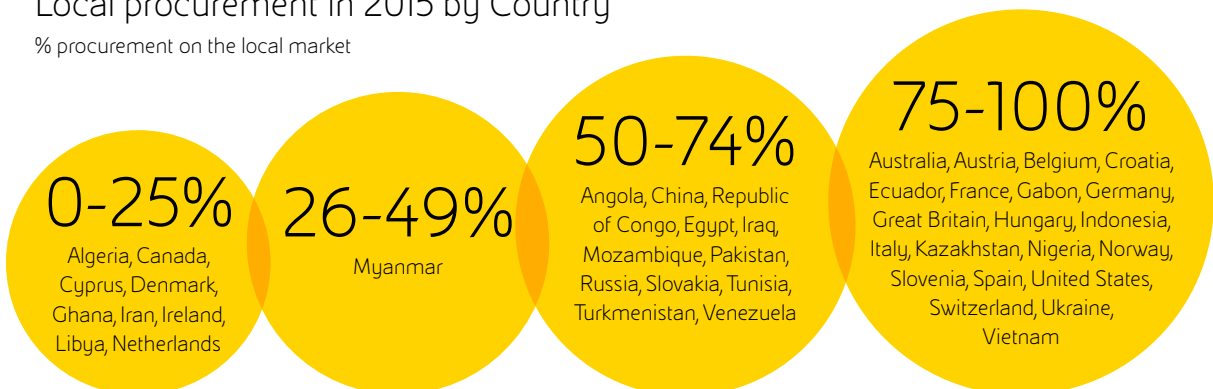

In Nigeria, the Green River Project (GRP), an integrated entrepreneurial development program for farmers in the Niger River Delta, was founded in 1987. The objective of such program was to transfer

technology through vocational guidance and training in order to increase food availability, multiply employment and earning opportunities and facilitate access to social services.



In Nigeria  
→ 35,000  
farmers involved

→ 500,000  
indirect beneficiaries  
in 120 communities

### Main results of the Green River Project in 2015

→ 4,000 km<sup>2</sup>  
current extension  
of the GRP intervention area

### The 19<sup>th</sup> edition of "Farmers' Day" of the Green River Project "Feeding the Country - Energy for life"

→ 235  
cooperatives currently  
assisted by GRP

→ 3,750  
young people and women  
educated from 1999 to date

In the scope of Protocollo di Intesa (Memorandum of Understanding) for the Gela Area, Eni has carried out a

technical feasibility study of an industrial plant for the production of 5,000 tons/year of natural rubber latex, from the

guayule tree through the development of a local agricultural chain.



### Education

Commitment to educational initiatives includes actions to support the entire learning process, from primary school to the university, and from professional training to on-the-job training.

Moreover, an agreement with the Provincial Department for Education and Culture of Mozambique, along with the City of Pemba and the Community Council of Paquitequete, provided for the construction of a primary school, the supply of scholastic materials and the conducting of awareness-raising activities that promote social and environmental themes.

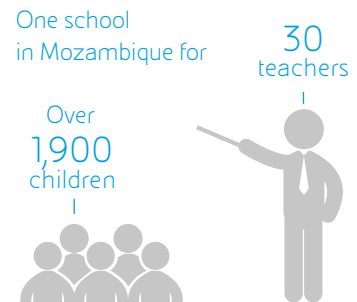

In Mozambique, the Eni Junior Professor (JP) project, initiated in 2014, envisages the education of 8 future oil&gas engineering instructors at the University of Mondlane in Maputo.



In Basilicata, support for school projects continues in collaboration

with the Eni Enrico Mattei Foundation, through innovative educational programs, including: 'little schools', a project dedicated to the primary school in Pergola with the objective of preventing its



shut down, through an intensive use of technologies and putting the school online with other Italian schools for combined educational activities; the scholastic tourism project that in 2015 allowed 1,200 students in Basilicata to explore the wealth

of energy present in their territory; NECTS (A New Energy Culture: Sustainability and Territories), a strategic partnership project financed by the European Commission as part of the Erasmus Plus program, involving Lucan

students and three high schools in Norway, Croatia and The Netherlands to promote the exchange of good practices among academic, scholastic and entrepreneurial sectors, based on themes linked to energy and sustainability.



## Health

In Angola, the capacity building project for medical and paramedical personnel was founded based on a collaboration between Eni and the Hospital Divina Providencia, involving 5 hospitals and 16 health centers.

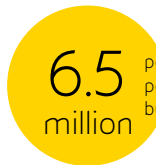

6.5 million population in the province of Luanda potentially benefitting from the capacity building project



22 educators



85 doctors



235 nurses



18 community agents

## Protection and valorization of resources

Eni promotes projects to protect and enhance environmental and local resources in harmony with

local communities. In this regard, integrated projects for water supply and usage are foreseen, promoting

access to water resources and favouring better hygienic and sanitary conditions.



The first results of the "Water wells project" were recorded in Palma, Mozambique during the year 2015. The project, which initiated in 2014, aims to improve the living, health & safety conditions of

approximately 4,000 people in the area of Palma, thanks to safe and enduring access to potable water. In 2015 a small water distribution network was created with three public dispensing points.



4,000 In Mozambique people now have access to drinking water

# Safety

Eni considers safety to be one of the most relevant themes for sustainability in a company, and promotes actions in the areas of both process and personal behaviour, in addition

to actions to improve emergency training and response. Over the last years, one of the priorities has been to increase safety along the supply chain.

The structural review project in vendor management has enabled a reassessment of the operating model and processes for supplier management and qualification.



The improvement trend in injury rates continued in 2015. The number of injuries decreased by over 46%

compared to 2014 and by over 88% compared to 2006, reducing events from 440 to 50 in 2015.

Despite these positive results, 1 fatal accident was recorded in 2015, involving a contractor in Nigeria.

## Total Recordable Injury Rate (TRIR)

Total recordable injuries/hours worked x 1,000,000

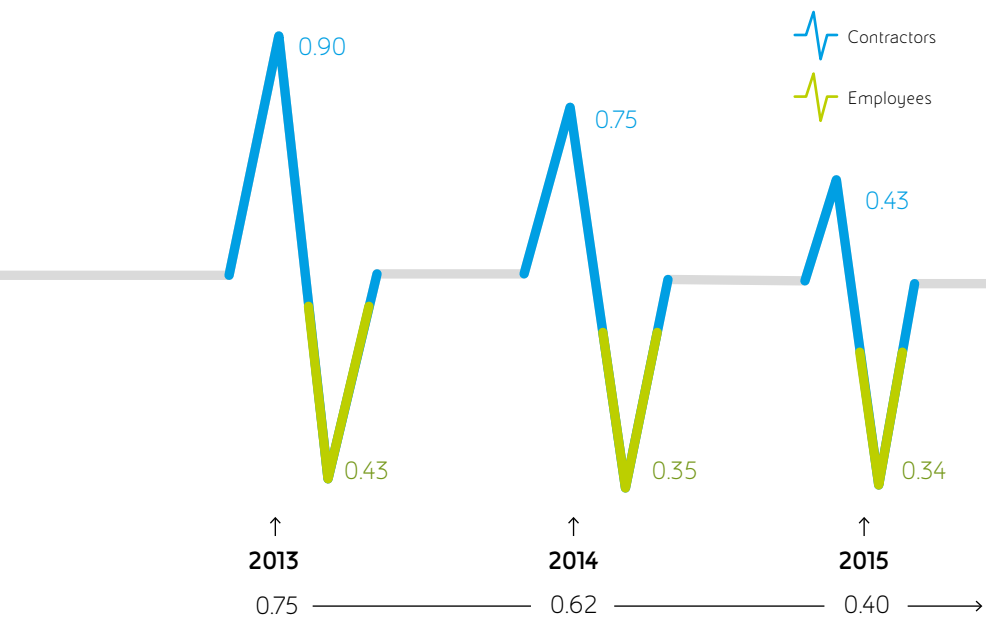

## TRIR

Compared with 2014

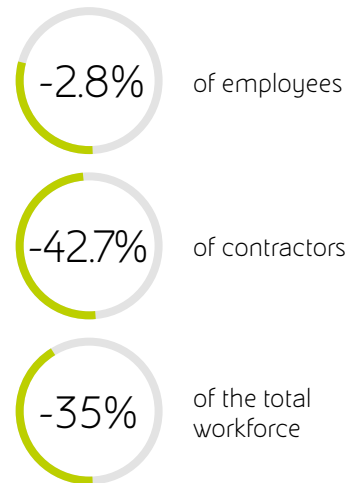

## Safety culture

For three years, Eni has been organizing the "Safety Road Show" at industrial sites in Italy and abroad: it is a series of top managements' meetings with employees and contractors, aimed at increasing awareness about safety. The meetings include the participation of different corporate departments, not only those directly effected by HSEQ issues, but also those related to procurement

and human resources. Eni CEO Claudio Descalzi attended some of the 2015 road show stops in Italy. Another event that promotes awareness of Eni personnel about safety issues, is Safety Day. It is the day where safety results and objectives are presented by corporate top management, celebrating best behaviours through awards and recognitions.



## Safety Competence Center - SCC

In 2015, Eni instituted the Safety Competence Center - SCC in Gela: a center of expertise in the safety sector at the service of all Group's operational units. The center is a pole of excellence on Safety and constitutes a part of the actions foreseen under the Memorandum of Understanding, signed with the Ministry of Economic Development. Under his Memorandum, and thanks to an investment plan of 2.2 billion euro, Eni aims at creating the conditions for a sustainable and long-term recovery in economic activities, ensuring solid employment prospects such as the conversion of the existing refinery into modern biorefinery, the upstream development activities and environmental rehabilitation activities. The SCC provides professional

services both in Italy and abroad, and is distinguished by its ability to offer a tailored service on-site specific features. The Center also offers standard management methodologies for activities with the support of specific softwares, as well as other tools that combine commitment and involvement: notably the "safety pact" established with contracted companies.

In parallel, a center for technical professional training was set up: the Safety Training Center (STC), using "field tests" of the Gela Refinery.

The STC is equipped with systems and structures that are useful for training in fire fighting, first aid and toxic gas. The STC, operative as of the first half of 2016, will provide its first fire fighting, first aid and specific risk training courses.



### OHSAS 18001<sup>6</sup>



### Investments and spending on safety

Million euro

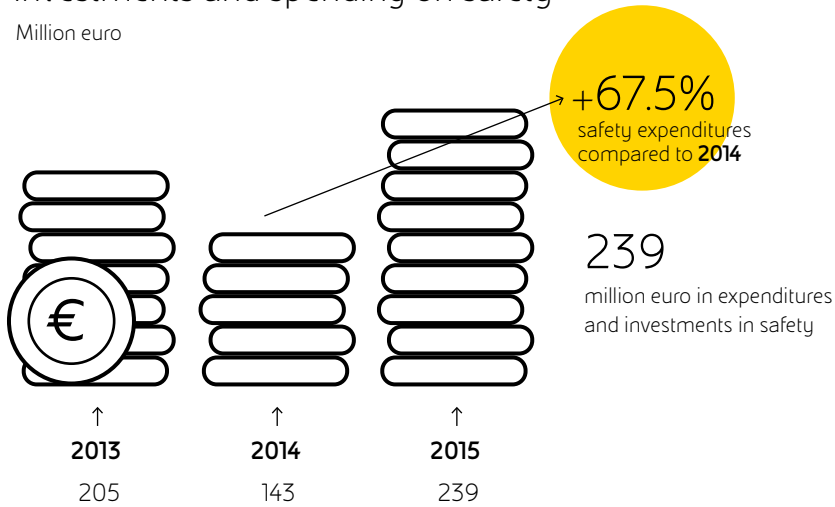

## Emergency prevention and management

To maintain the highest levels of preparation in response to emergencies, over 130 drills of different levels of complexity were conducted in 2015. In particular, these included the

simulation of: rupture of the ammonia pipes at an industrial site, a hydrogeological event, a collision between a holding tanker and gas platform with spillage of gasoline.

Three national drills were also conducted in coordination with the DPC\* regarding the international tsunami: "early warning system in the Mediterranean Sea basin".

6) Occupational Health & Safety Accountability Standard is an international standard for worker safety and health management.

\* Civil Protection Department.





CHIEF EYE  
1731

MADE IN THE USA  
SILVER MOUNTAIN CO.



# People

Eni promotes a culture guided by integrity values and equal opportunity policy, fostering aware and responsible behaviours and creating initiatives that enhance diversity and professional development pathways.

## Eni people

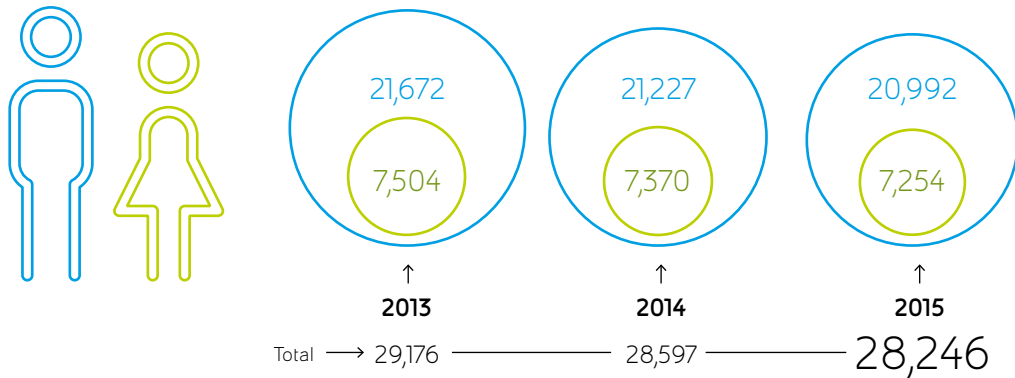

## Employees by geographic area

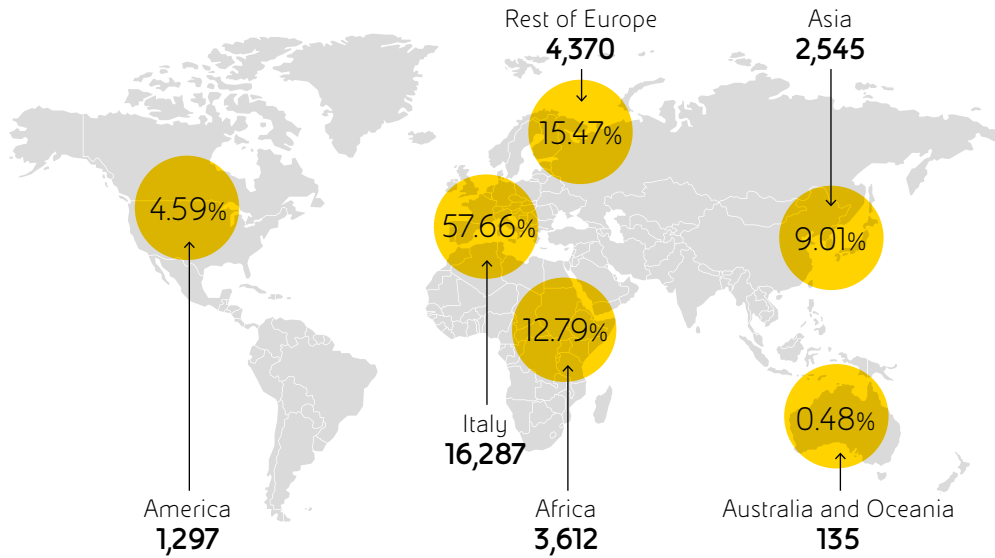

## Development of an integrity culture

To disseminate the values of integrity at all organization levels, in Italy and abroad, the project 'Responsible Leadership' was extended to the training of 5,000 people through webinars in 2015.

In reference to "non discrimination", and with the collaboration of the ILO (International Labour Organization), a webinar was organized for managers, senior managers and Human

Resources Departments, with an overall participation of 10,000 people, 8,500 people in 2015 and 1,500 in 2014; an informative/formative webinar is also accessible to all Eni people on the intranet site.

## Equal opportunity for people

### Women in management positions (%)

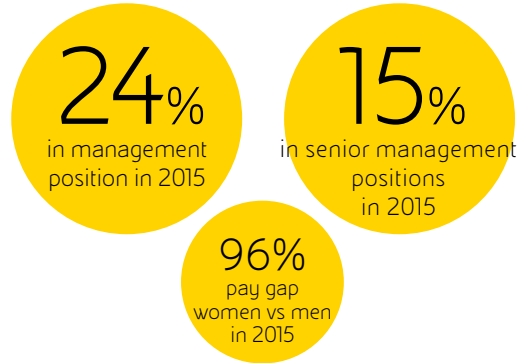
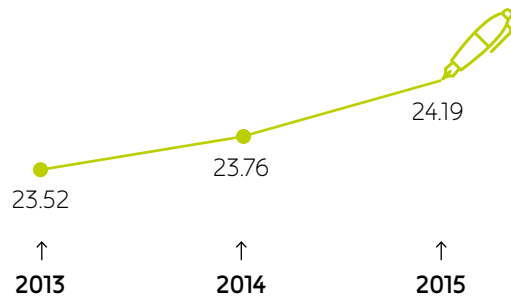

## Actions for the promotion of equal opportunities for people

Attracting female employees	Equal treatment	Worklife balance	Female presence in the Board
<ul style="list-style-type: none"> <li>→ Organization of events at universities, schools and job fairs dedicated to female students/graduates</li> <li>→ Enhancement of the "work with us" section on the eni.com website with testimonials from female professionals</li> </ul>	<ul style="list-style-type: none"> <li>→ Monitoring of female population</li> <li>→ Training and mentorship/counselling for supporting personal and professional development</li> <li>→ Control of the salary equity situation</li> </ul>	<ul style="list-style-type: none"> <li>→ Worldwide application of the Convention ILO 183, for maternity leave and compensation</li> <li>→ Consolidation of initiatives to support employees with children (summer camps, study abroad, etc.)</li> <li>→ Feasibility study for the creation of a Second company nursery</li> </ul>	<ul style="list-style-type: none"> <li>→ 31.7% presence of women in the Boards of Directors of subsidiaries reached (Eni designated assignments) in Italy</li> <li>→ Gender representation with 25% female appointments, extended also in foreign boards</li> </ul>

The protection of the right to maternity represents a fundamental value for Eni. For this reason, a study was carried out to identify any divergences from the standard ILO - Convention 183 - that governs maternity and the laws/corporate policies of

the Countries of presence. In light of the results emerged from the study, a procedure was adopted in 2015 to guarantee application of the minimum standards set forth in the ILO convention to all the women of Eni around the world.



Eni supports, through dedicated policies, the integration of people into the social context of the Countries where it operates, and promotes actions in favour of the development of local people. For this purpose:

- a new HR computer system was developed to handle

planning and recruitment processes to achieve a greater management uniformity at a global level;

- collaborations with international universities were reinforced - in particular in Angola, Ghana and Mozambique. The aim is to

select young graduates and support local content in Countries, creating a pole of excellence for strategic Upstream subjects, by training internal instructors at the Mondlane University of Maputo;

- initiatives directed at high



schools students were launched in Ghana and Mozambique, to promote awareness about energy and

environment issues;  
 • during the 'Global Business Network for Social Protection Floors', practices were shared

with multinationals related to social security (pensions, maternity, paternity, disability compensation, etc.).

### Local employees abroad by professional category

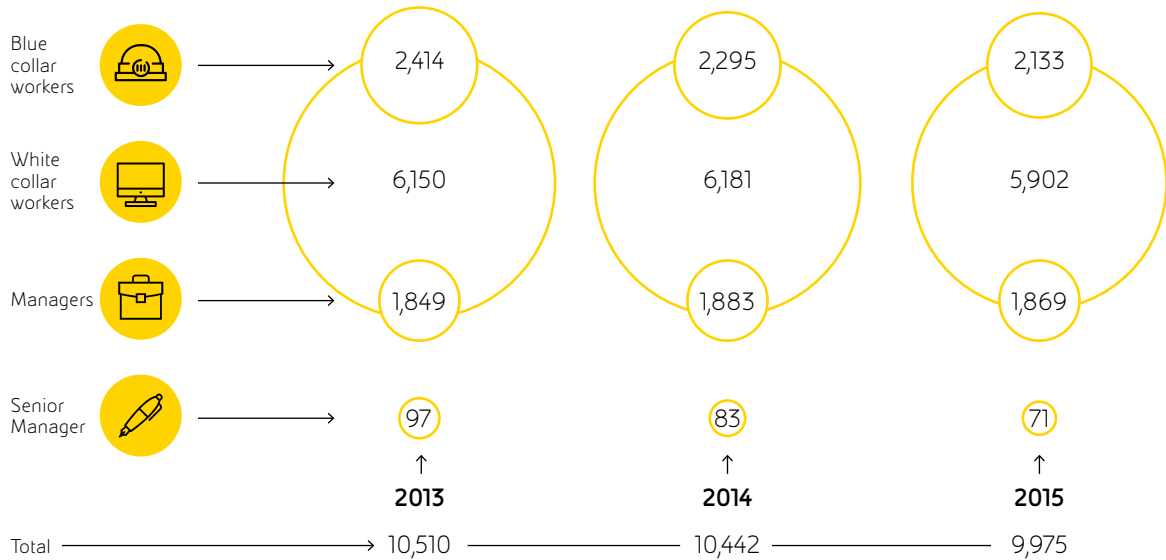

### Ratio between Eni minimum wage policy and market minimum wage (1<sup>st</sup> decile)

Middle manager - Senior staff

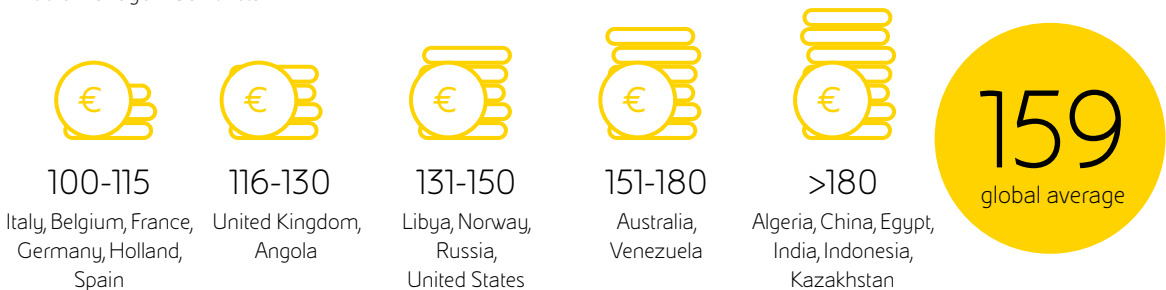

### Skill enhancement

In 2015 Eni followed three directives: to standardize the repertoire of professional skills, the definition of a step-by-step approach aimed at identifying the

required professional standards and updating of the most strategic areas for the business to identify Knowledge owners with technical vocation. Furthermore,

initiatives designed for the development of long-distance training have been promoted, with the support of the most advanced technological platforms.



# Environment

Eni considers environmental protection to be an essential component of sustainable development for the realization of its industrial projects, and is committed to integrating this objective in all of its activities for the entire life cycle of its plants and in all of the operating sites where it operates. Management of environmental

issues is based on the adoption of an environmental management system (SGA). Such system is integrated with health and safety aspects, in line with sustainability and integrity principles, set forth in the respective Eni policies. Sustainability and performance objectives are monitored and managed on a six-month basis.

ISO 14001 certification program at 98% in 2015 with completion scheduled for 2016

## Environmental Management System activities

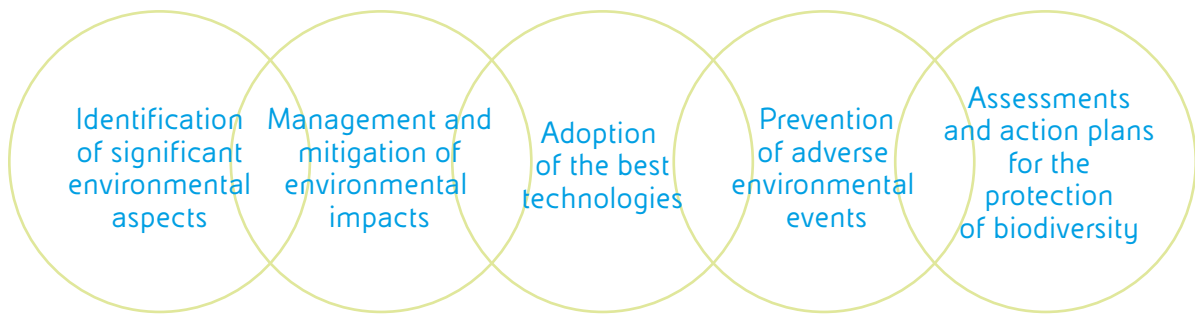

## Water withdrawals

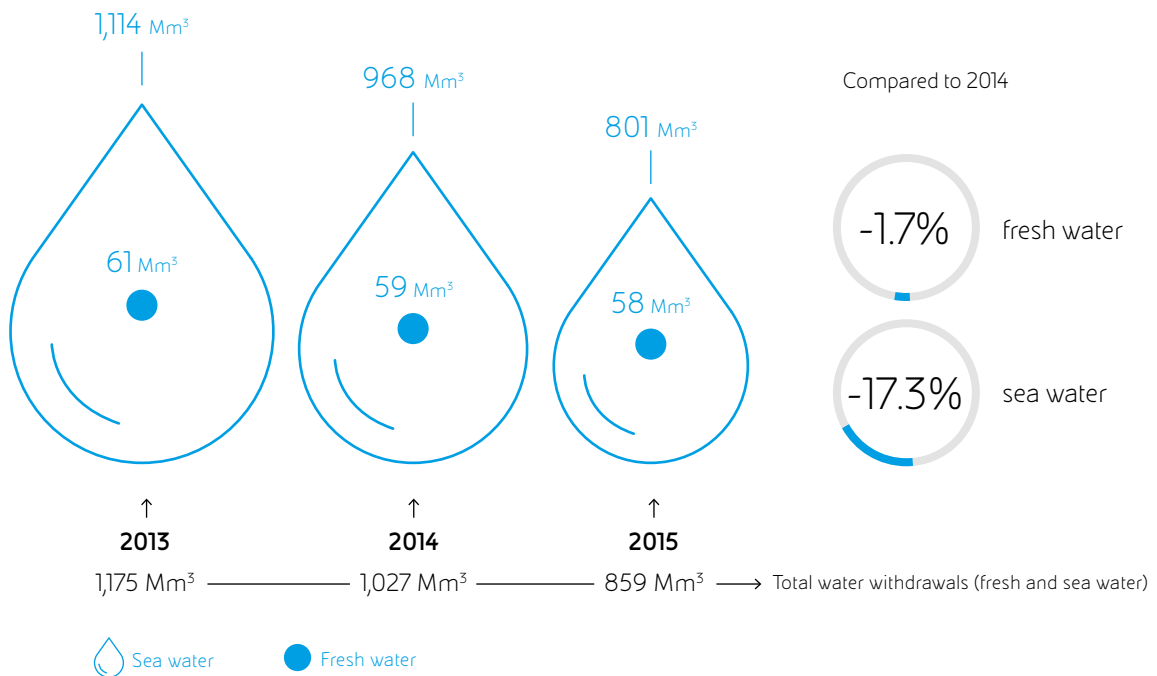

## Efficient use of water

The efficient use of water and the use of the best technologies for treatment of wastewater are the principles applied by Eni in all of the operating sites. Eni performs an annual mapping and monitoring of water risks and drought scenarios to define long-term actions, to prevent and mitigate the effects of climate change as well. All the new projects include water risk analyses

that take into consideration current and future scenarios.

**In 2015 less than 20% of the plants are in areas of water stress for fresh water withdrawal equal to 5% of the total**

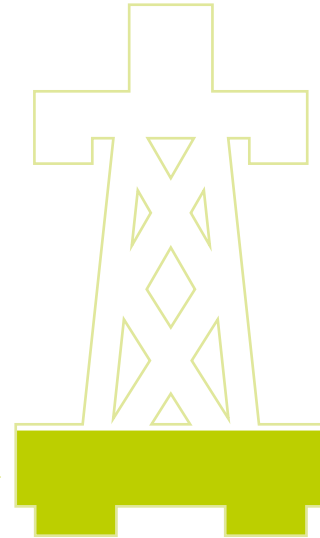

In the sites with the greatest consumption, local plans were initiated for the management of water. In particular, in 2015, the water withdrawal reduction objectives were reached in Algeria and Egypt defined as areas subject to water stress. Eni guarantees the priority of minimizing waste by committing to reuse and recycle

water for industrial purposes, especially in areas with scarce water resources. These actions are designed to guarantee protection and monitoring of underground and surface waters. In the Upstream sector, a program has been underway, since 2006 to increase the percentage of fossil waters (water separated from the

extracted raw petroleum) that are reinjected into the reservoir, contributing to sustaining oil production by maintaining high pressure in the reservoir. This practice is the chosen method as an international standard aimed at reinjecting the reservoir waters into their original geological formations.

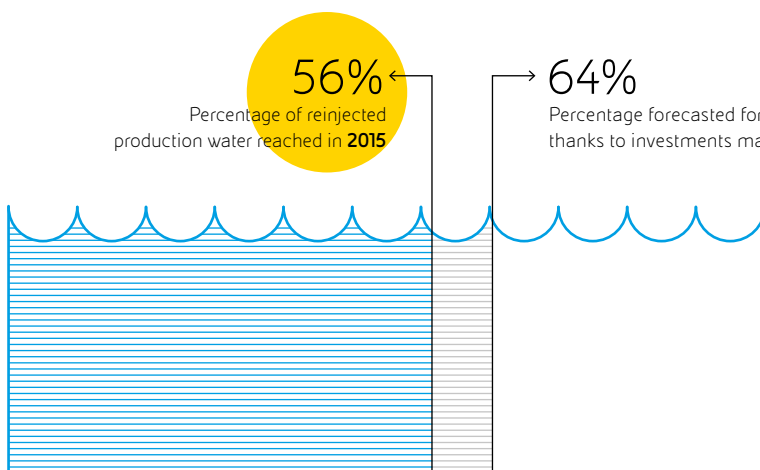



In the Downstream sector, reclamation waters are re-evaluated for use by the subsidiary company

Syndial, making large volumes of water available through its groundwater treatment plants (TAF):

over the next 4 years, these volumes of water will comprehensively increase from 3.5 to 5.5 Mm<sup>3</sup>/year.

## Managing oil spills

Eni pursues oil spill prevention activities with direct interventions on assets and progressive replacement of tanks and pipelines.

-  Oil spills caused by sabotage
-  Operational oil spills

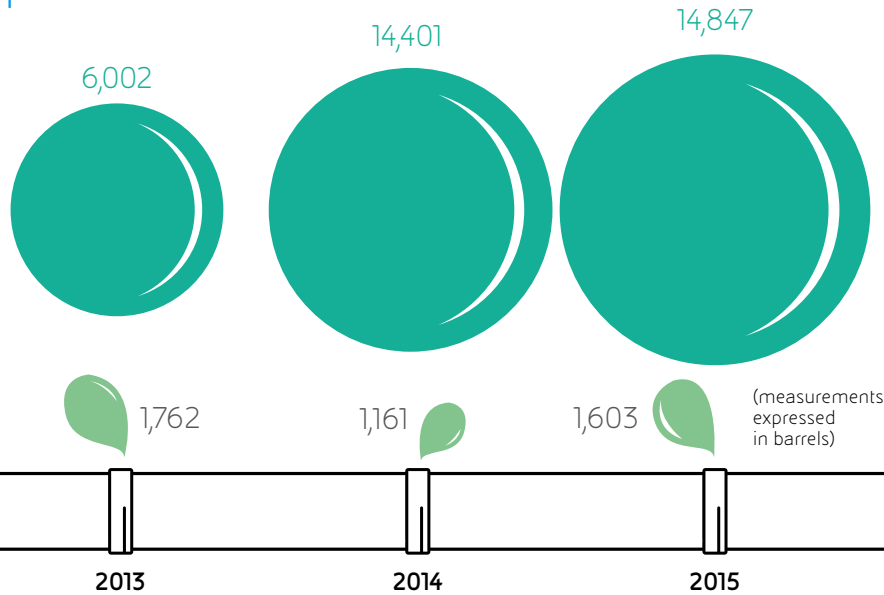

**In 2015, 35 million euro invested in oil spill prevention, +19% compared to 2014**

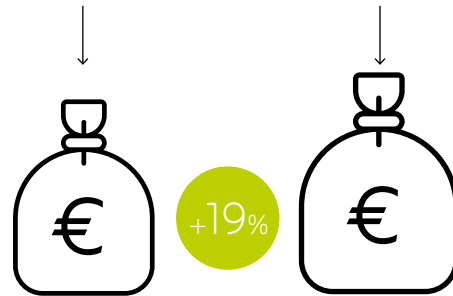

Eni's commitment to preventing and limiting the effects of sabotage along its network of pipeline continues. In 2015, 158 sabotage/theft events occurred along the 3,000 km of managed pipeline in Nigeria. Despite the fact that the number of events has decreased significantly (284 in 2014), the relative volumes of the spills have grown (10,530 barrels in 2015 in respect to 6,610 in 2014).

In Italy the number of sabotage events is significantly increasing compared to last year, though it is also characterized by a

significant reduction in volumes spilled, which is a proof of a growing ability to react and intervene. Numerous preventive activities have been implemented, paying a particular attention to advanced technologies related to pipelines' active safety, such as sophisticated systems of video surveillance. Activities designed to improve velocity and quality of the response continue: for example, the implementation of the eVPMS system\* (Eni Vibroacoustic Pipeline Monitoring System) by 2016, along the entire national network of operating pipelines, and the completion

of the pilot phase of the "Support for oil pipeline emergency spill network" project (completion scheduled by April 2016). Improvement in the management of emergencies is also being pursued through participation in several international initiatives to coordinate response to possible spills. One example is the advancement of the "COSPIP Project" (Coastal Oil Spill Preparedness Improvement Programme) focused on the critical area of the Barents Sea. Another example is the "Oil Spill Response Joint Industry Programme" by IPIECA-IIOGP.





# Reporting principles and criteria

## Reporting system

In 2015, Eni drew up Integrated Annual Report in accordance with the principles of the International Integrated Reporting Council's (IIRC) framework. In order to provide a more in-depth and comprehensive view of the mechanisms used to create value, and the contribution made to achieving the global development goals, Eni decided in 2015 to produce "Eni for 2015 -

Sustainability Report" (hereinafter "Eni for 2015"). The document is prepared in accordance with the new "G4 Sustainability Reporting Guidelines and Oil & Gas Sector Disclosures" issued by the Global Reporting Initiative (GRI) with a self-declared level of compliance "in accordance - core" and taking into consideration the "Oil & Gas industry guidance on voluntary sustainability reporting" contents produced by IPIECA/API/OGP.

The contents of Eni for 2015 are also in line with the Advanced Level of the Differentiation Programme and with the additional sustainability aspects provided by the Blueprint for Corporate Sustainability Leadership of the UN Global Compact. Lastly, eni.com provides further information on sustainability issues in order to supplement the information provided in its reports.

## Materiality, boundary and quality principles

Materiality is the result of a process of identification, evaluation and prioritization of sustainability issues that significantly impact on the Company's capacity to create value in the short, medium and

long-term (please see pag. 8 Materiality Analysis). The process involves an analysis aimed at identifying the boundary of the various aspects in relation to the potential impact both inside and

outside Eni. In the coming years Eni will focus on the identification and implementation of specific actions aimed at expanding the scope of the material aspects collection and reporting.

The performance indicators are related to the period 2013-2015 issued by Eni SpA and its consolidated subsidiaries. The consolidation perimeter is the same as that for the 2015 consolidated financial statements, with the exception of certain data expressly mentioned in the text. Data are presented for the three-year period net of Saipem, due to the sale of 12.503% of Saipem SpA to the Fondo Strategico Italiano SpA in January 2016, and net of Versalis, as the sale agreement related to a portion of control was still underway on 31 December 2015. The HSE data are defined according to the operations control criterion. Data related to people refer only to consolidated companies based on the line by

	Aspect Boundary		
	Inside	Outside	Limitations
Economic performance	●		
Market presence	●		
Indirect economic impact	●		
Procurement practices	●	S	RNES
Energy	●		
Water	●		
Effluents, Biodiversity	●		
Emissions	●	S,C	RPES
Occupational health and safety	●	S	
Training and education	●		
Security practices	●	LSF	
Supplier Human Rights Assessment	●	S	RNES
Supplier Environmental Assessment	●		
Supplier Assessment for Labor Practices	●		
Local communities	●		
Anti-Corruption	●	S	RPES
Asset Integrity and Process Safety (sector disclosure)	●		
Fossil fuel substitutes (sector disclosure)	●		

Legenda: C = Customers; S = Suppliers; LSF = Local Security Forces; RNES = Reporting not extended to suppliers  
RPES = Reporting partially extended to suppliers

line method. The detection of the information and data is structured in a way to ensure the comparability of data across years. The Report was subject to a limited assurance engagement by an independent company, auditor

of Eni Group's consolidated financial statement as of 31 December, 2015. The audited data and information are marked with the "External Assurance" label in the "GRI Content Index" (see Annex "GRI Content Index").



# Independent Auditors' Report



Reconta Ernst & Young S.p.A. Tel: +39 06 324751  
Via Po, 32 Fax: +39 06 32475504  
00198 Roma ey.com

## Independent auditors' report on "Eni for 2015 - Sustainability Report" (Translation from the original Italian text)

To the Board of Directors of  
Eni S.p.A.

We have carried out a limited assurance engagement of "Eni for 2015 - Sustainability Report" (hereinafter also the "Report") of Eni S.p.A. and its subsidiaries (hereinafter "Eni Group") as of December 31, 2015.

### Directors' responsibility on the Report

The Directors are responsible for the preparation of the Report in accordance with the "G4 Sustainability Reporting Guidelines" and "Oil & Gas Sector Disclosures", issued in 2013 by GRI - Global Reporting Initiative, that are detailed in the paragraph "Reporting principles and criteria" of the Report, as well as for that part of internal control that they consider necessary in order to allow the preparation of a Report that is free from material misstatements, even caused by frauds or not-intentional behaviors or events. The Directors are also responsible for defining the Eni Group's commitments regarding the sustainability performance and for the reporting of the achieved results, as well as for the identification of the stakeholders and of the significant matters to report.

### Auditors' responsibility

It is our responsibility the preparation of this report on the basis of the procedures carried out. Our work has been conducted in accordance with the criteria established by the principle "International Standard on Assurance Engagements 3000 - Assurance Engagements other than Audits or Reviews of Historical Financial Information" ("ISAE 3000"), issued by the International Auditing and Assurance Standards Board for the engagements that consist in a limited assurance. This principle requires the respect of relevant ethical principles, including those related to independence, as well as the planning and the execution of our work in order to obtain a limited assurance that the Report is free from material misstatements. These procedures included inquiries, primarily with company's personnel responsible for the preparation of the information included in the Report, documents analysis, recalculations and in other procedures in order to obtain evidences considered appropriate.

Reconta Ernst & Young S.p.A.  
Sede Legale: Via Po, 32 - 00198 Roma  
Capitale Sociale € 1.400.000,00 i.v.  
Iscritta alla S.O. del Registro delle Imprese presso la C.C.I.A.A. di Roma  
Codice fiscale e numero di iscrizione 00434000584 - numero R.E.A. 250904  
P.IVA 00891231003  
Iscritta all'Albo Revisori Legali al n. 70945 Pubblicato sulla G.U. Suppl. 13 - IV Serie Speciale del 17/2/1998  
Iscritta all'Albo Speciale delle società di revisione  
Consob al progressivo n. 2 delibera n. 10631 del 16/11/1997  
A member firm of Ernst & Young Global Limited



The procedures performed on the Report were related to the compliance with the principles for defining report content and quality, as articulated in the "G4 Sustainability Reporting Guidelines", and are summarized below:

- a. Comparison of the economic and financial data and information included in the Report with those included in the Eni Group's consolidated financial statements as of December 31, 2015 on which we issued our audit report, pursuant to art. 14 and 16 of Legislative Decree dated January 27, 2010, n.39, on April 12, 2016;
- b. Analysis, through interviews, of the governance system and management process of the issues related to sustainable development regarding Eni Group's strategy and operations;
- c. Analysis of the process relating to the definition of material aspects included in the Report, with reference to the identification modalities in terms of their priority for the different stakeholders' categories and to the internal validation of the process outcome;
- d. Analysis of the operation of the processes that support the generation, recording and management of the quantitative data reported in the Report. In particular, we have carried out the following procedures:
  - interviews and discussions with personnel of the Corporate and Business Units of Eni S.p.A., and of the subsidiary Eni Angola Production BV, to obtain an understanding about the information, accounting and reporting system in use for the preparation of the Report, as well as about the internal control processes and procedures supporting the collection, aggregation, data processing and transmission of data and information to the department responsible for preparation of the Report;
  - on-site verifications at Livorno Refinery and Ocean Rig's Drilling Rig Poseidon (Angola);
  - analysis on a sample basis of the documentation supporting the compilation of the Report, in order to confirm the processes in use, their adequacy and the operation of the internal control for the correct reliability of data and information in relation to the objectives described in the Report;
- e. Analysis of the compliance and internal consistency of the qualitative information included in the Report to the guidelines identified in paragraph "Directors' responsibility on the Report" of the present report;
- f. Analysis of the process relating to the stakeholders engagement, with reference to the procedures applied, through the review of summary minutes or any other existing documentation relating to the main topics emerged from discussions with them;
- g. Obtaining of the representation letter, signed by the legal representative of Eni S.p.A., relating to the compliance of the Report with the guidelines indicated in paragraph "Directors' responsibility on the Report", as well as to the reliability and completeness of the information and data presented in the Report.



The data and information which are subject to the limited assurance are reported, in compliance with "G4 Sustainability Reporting Guidelines", in the table "GRI Content Index" of the Report.

No procedures have been performed on data and information reported in the Annex "Eni for Transparency" of the Report.

Our examination has entailed a lower extension of work compared to the work to be performed for a reasonable assurance engagement in accordance with ISAE 3000 and, as consequence, we may not have become aware of all the significant events and circumstances which we could have identified had we performed a reasonable assurance engagement.

#### **Conclusion**

Based on our work, nothing has come to our attention that causes us to believe that "Eni for 2015 - Sustainability Report" of Eni Group as of December 31, 2015 is not in compliance, in all material aspects, with the guidelines "G4 Sustainability Reporting Guidelines" and "Oil & Gas Sector Disclosures" issued in 2013 by the GRI - Global Reporting Initiative, as stated in the paragraph "Reporting principles and criteria" of the Report.

Rome, May 3<sup>rd</sup>, 2016

Reconta Ernst & Young S.p.A.  
Signed by: Massimo Antonelli, Partner

*This report has been translated into the English language solely for the convenience of international readers*





Eni SpA

**Registered Office**

Piazzale Enrico Mattei, 1 - Rome - Italy  
Share capital: € 4,005,358,876.00 fully paid-up  
Business Register of Rome  
taxpayer's code 00484960588

**Other Branches**

Via Emilia, 1  
San Donato Milanese (MI) - Italy

Piazza Ezio Vanoni, 1  
San Donato Milanese (MI) - Italy

**Page layout and supervision**

Korus Srl - Rome

**Print**

Tipografia Facciotti



Printed on XPer Fedrigoni paper



